

---

# RETURN TO WORK

Product Specifications	2
Product Options	3
Product Pages	7

# RETURN TO WORK

## PRODUCT SPECIFICATIONS

### SCREENS

#### DESKS+WORKSTATIONS+BENCHING+TABLES

Accommodate new ways of working by utilizing your existing products and blending new solutions into workspaces

Create space division by adding a screen to your workspace. Select the screen style that best fits your situation: set on surface, edge mount, clamp mount, full metal edge mount, or freestanding

- Select style and height of screen based on floorplate layout and occupancy density. Taller screens are appropriate when employees must be situated face-to-face or are near high traffic areas
- Create additional shielding by adding set on surface screens to stations that already have existing edge mount screens
- Screens are available in a variety of materials. Be sure to specify bleach cleanable textiles or hard surfaces such as acrylic
- Bulk pack pricing available – save money and reduce onsite packing materials by choosing this option. Contact our By Design Product Modifications Team for a price quote.

Keep in mind that it is essential to balance the need for privacy and protection with the overall feeling of the workplace environment.

Note: If you require screens that move with a height-adjustable worksurface, you will have to remove center screens. National recommends a 1" clearance on all sides to avoid pinch point hazards



Accessory Edge Mount Screens with Alloy Height Adjust + Epicenter Spine and Screens + Waveworks Pedestals



Accessory Edge Mount Screen + Alloy Height Adjustable Desk

#### DIMENSION KEY

D	Depth
W	Width
H	Height
A	Overhang: Approach Side
KW	Kneespace Width
DI	Diameter

**SCREENS**

**SCREEN TYPE**

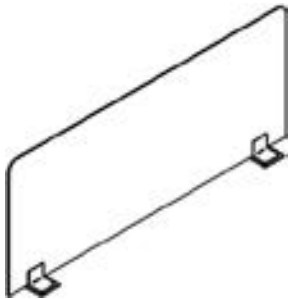

**Set-On**

Comes in Polycarbonate QD  
 30"H, 24"W, 21-72"W  
 Comes in 2 Resins Standard Lead Time  
 Comes in PET Standard Lead Time  
 30"H, 24"W, 18"H, 21-72"W  
 1 person to install

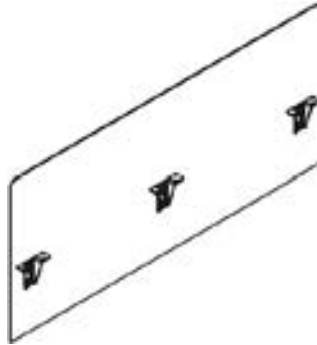

**Edge Mount**

Comes in Polycarbonate QD  
 40/34"H, 30/24"H, 24/18"H, 21-72"W (privacy)  
 44/30"H, 38/24"H, 32/18"H, 21-72"W  
 (privacy/modesty)  
 Comes in 2 Resins Standard Lead Time  
 Comes in PET Standard Lead Time  
 Comes in 3 Vertical Textile Patterns Standard  
 Lead Time  
 40/34"H, 30/24"H, 24/18"H, 21-72"W (privacy)  
 44/30"H, 38/24"H, 32/18"H, 21-72"W  
 (privacy/modesty)  
 2 people to install

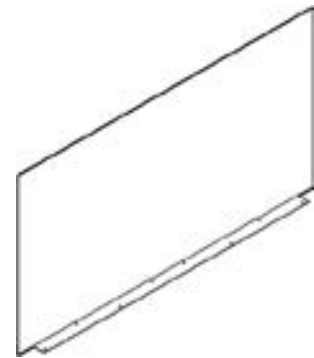

**Full Metal Edge Mount**

Comes in 2 Resins Standard Lead Time  
 Comes in Glass Standard Lead Time  
 24"H, 23-72"W  
 2 people to install

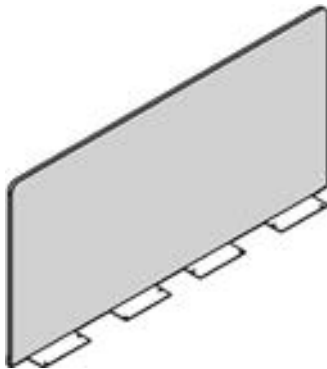

**Full Edge Mount: PET**

Comes in 1 PET Standard Lead Time  
 24-30"H, 23-72"W  
 2 people to install

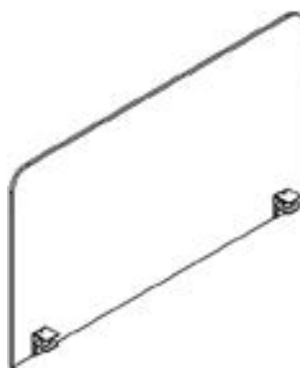

**Clamp Mount**

Comes in TFL White Laminate/Platinum Metallic  
 paint brackets QD  
 27H, 23-71W  
 Comes in 2 Resins Standard Lead Time  
 27"H, 23-71"W  
 1 person to install

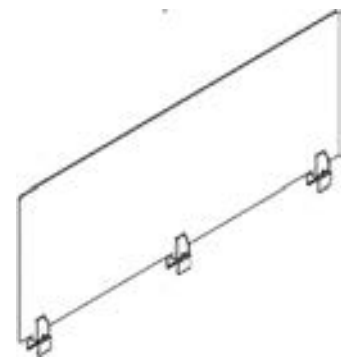

**Universal Panel Mount**

Comes in 2 Resins Standard Lead Time  
 Comes in Glass Standard Lead Time  
 18"H, 24-48"W  
 2 people to install



Shaded model numbers are available on our  
 "To You in 10 Days or Less" Quick Delivery  
 program and will be delivered in 10 days or less.

## RETURN TO WORK

---

### SCREENS, *continued*

#### SCREEN TYPE

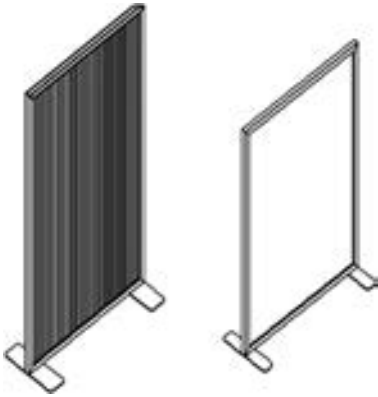

##### **Static Floor Screen**

Comes in Reeded Polycarbonate Standard Lead Time  
Comes in Glass Standard Lead Time  
Comes in HPL Laminate Standard Lead Time  
Comes in HPL Marker Board Laminate Standard Lead Time  
Comes in PET Standard Lead Time  
Comes in 3 Vertical Textile Patterns Standard Lead Time  
60"H or 72"H, 24-48"W  
2 people to install

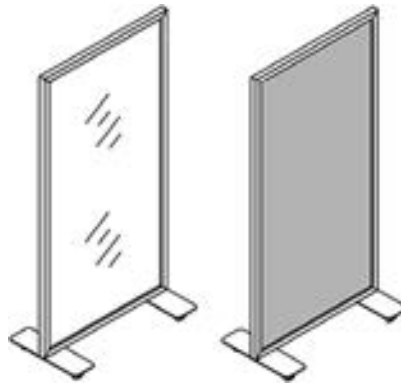

##### **Mobile Floor Screen**

Comes in Reeded Polycarbonate Standard Lead Time  
Comes in Glass Standard Lead Time  
Comes in HPL Laminate Standard Lead Time  
Comes in HPL Marker Board Laminate Standard Lead Time  
Comes in PET Standard Lead Time  
Comes in 3 Vertical Textile Patterns Standard Lead Time  
60"H or 72"H, 24-48"W  
2 people to install

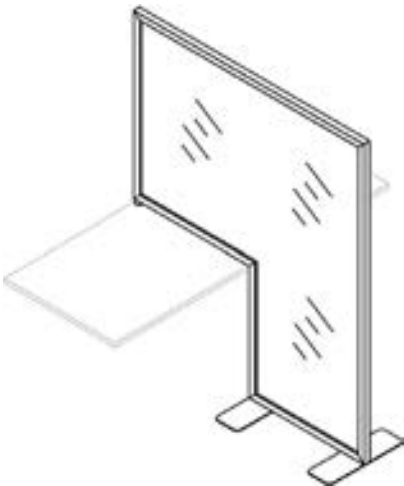

##### **Static Surface/Floor Screen**

Comes in Reeded Polycarbonate Standard Lead Time  
Comes in Glass Standard Lead Time  
Comes in HPL Laminate Standard Lead Time  
Comes in HPL Marker Board Laminate Standard Lead Time  
Comes in PET Standard Lead Time  
Comes in 3 Vertical Textile Patterns Standard Lead Time  
60"H or 72"H, 24-48"W  
2 people to install

**ACCESSORIES**

**EQUIPMENT RAIL**



**Wall Equipment Rail**

Extruded Aluminum Rail with Silver Inlay  
18¼"-48¼"W  
2 people to install

**ACCESSORIES FOR RAIL (1 PERSON INSTALL)**

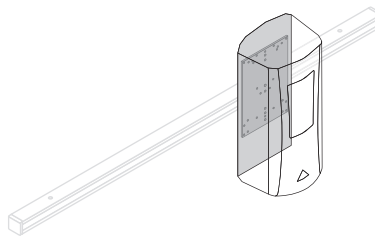

**Mounting Kit for Wide-Body Soap/Sanitizer Dispenser**

Designed to hold most wide-body soap or sanitizer dispensers

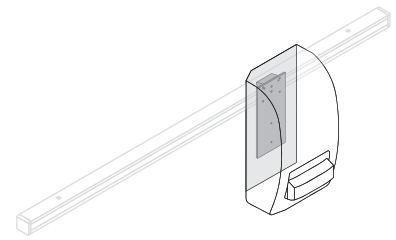

**Mounting Kit for Narrow-Body Soap/Sanitizer Dispenser**

Designed to hold most narrow-body soap or sanitizer dispensers

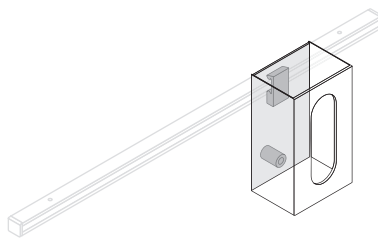

**Single Universal Glove Box Holder**

Clear Acrylic  
Holds one glove box

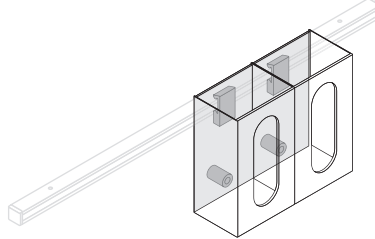

**Double Universal Glove Box Holder**

Clear Acrylic  
Holds two glove boxes

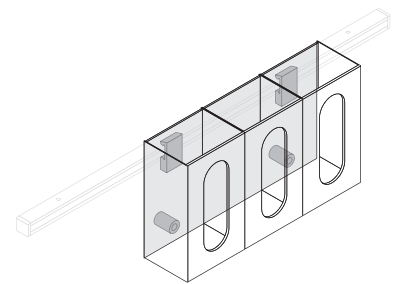

**Triple Universal Glove Box Holder**

Clear Acrylic  
Holds three glove boxes

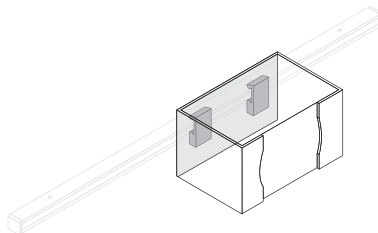

**Small PPE Dispenser**

ABS plastic  
Universal small box dispenser for shoe cover, cap, and other items

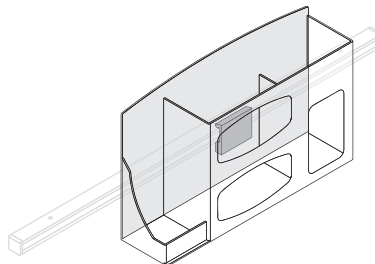

**PPE Dispenser Cabinet**

Holds 2 boxes of gloves, 1 box of face masks, and 1 hand sanitizer bottle

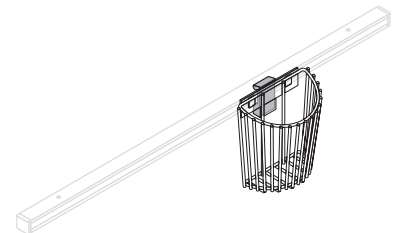

**U-Shaped Wire Basket**

Plastic coated wire  
Holds blood pressure cuff and other accessories

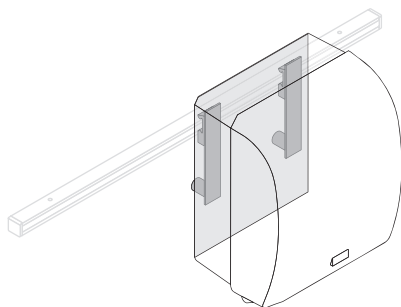

**Mounting Kit for Paper Towel Dispenser**

Designed to hold most paper towel dispensers

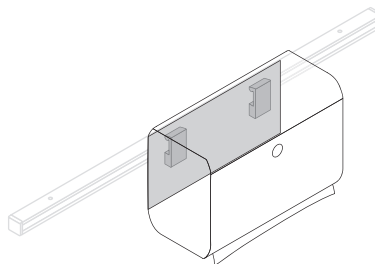

**Mounting Kit for Tri-Fold Paper Towel Dispenser**

Designed to hold most tri-fold dispensers

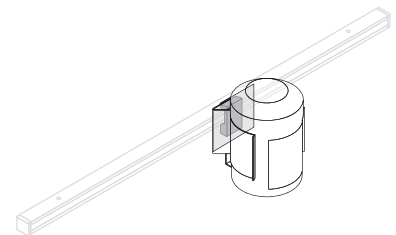

**Wipe Holder**

Designed to hold most brands of sanitizing wipes and some industrial style spray bottles

# RETURN TO WORK

## SCREEN PRODUCT OPTIONS

### LAMINATE+BRACKET OPTIONS

#### CLAMP MOUNT TFL WOODGRAIN LAMINATE

IM Brighton  
MC Amber  
MH Mocha

#### CLAMP MOUNT TFL SOLID LAMINATE

405 Designer White  
440 Cloud  
461 Graphite  
462 Cinder

#### POLYCARBONATE

Fluted, Semi-Opaque Polycarbonate

#### EDGE MOUNT AND SET-ON BRACKET PAINT COLORS

423 Concrete  
462 Cinder  
463 Iron  
501 Platinum Metallic  
503 Satin Nickel Metallic

#### CLAMP MOUNT AND FULL EDGE MOUNT BRACKET, AND FLOOR SCREEN FRAME PAINT COLORS

405 Designer White  
462 Cinder  
501 Platinum Metallic

#### RESIN COLORS

1677 Frosted  
1377 Clear

#### EDGE MOUNT BRACKET APPLICATION

FL Flush  
WG Wire Gap (+\$36 upcharge)

#### FLOOR SCREEN LAMINATE COLORS

793 Acorn	TM Huntington
AD Almond	DW Judicial
MC Amber	KN Kona
AC2 Autumn 2	MW Midtown
BZ Brazilwood	MH Mocha
IM Brighton	YO Monterey
CO Canyon	NM Natural
CL Caramel	478 Platinum Grey
CI Chai	PC Porcini
462 Cinder	PT Portico
492 Cinder Linear	PB Portobello
440 Cloud	792 Sable
CC Cordoba	SC Sedona
CW Cordovan	425 Shadow
457 Dapple	SK Skyline
405 Designer White	460 Storm
491 Designer White Linear	TW Tribeca
DF Driftwood	TF Truffle
450 Fog	NW Tuscan
488 Frosty White	UW Urban
461 Graphite	419 Wallaby
HN2 Honey 2	WL Willow

### PET+VERTICAL TEXTILE OPTIONS\*

#### PET

NOR Nordic Knit

#### TACK BOARD VERTICAL TEXTILES OPTIONS

Grade A	Grade B
Compose	Basket
Crossroads	Frenzied
Dune	Fuse
Fusion	Linen
Infuse	Lyko
Meander	Pact
Merge	Prose
Mykel	Savile
Plinth	
Repetition	
Tapestry	COM (Grade B)
Universe	

\*Available for Clamp Mount, Full Edge Mount, and Floor Screens

# SET-ON SCREEN - DESKS+BENCHING



Shaded model numbers are available on our "To You in 10 Days or Less" Quick Delivery program and will be delivered in 10 days or less.

### TO ORDER, SPECIFY:

1. Model Number

### SAMPLE MODEL NUMBER:

NAC7230PVSBP

- See page 3 for Return To Work options

- Quick Delivery lead times applicable to orders of 20 screens or less

	MODEL NO./DESCRIPTION	LIST PRICE	DIMENSIONS					CARTONED CUBIC	
			D	W	H	A	KW	WEIGHT	FEET
<b>POLYCARBONATE SET-ON SURFACE SCREEN</b>  	<b>¼" POLYCARBONATE THICKNESS</b>								
	<b>30" HIGH</b>								
	NAC7230PVSBP	\$ 663	72	30					
	NAC6630PVSBP	651	66	30					
	NAC6030PVSBP	636	60	30					
	NAC5430PVSBP	625	54	30					
	NAC4830PVSBP	537	48	30					
	NAC4230PVSBP	534	42	30					
	NAC3630PVSBP	448	36	30					
	NAC3030PVSBP	403	30	30					
	NAC2730PVSBP	344	27	30					
	NAC2430PVSBP	336	24	30					
NAC2130PVSBP	330	21	30						
<b>24" HIGH</b>									
NAC7224PVSBP	\$ 618	72	24						
NAC6624PVSBP	609	66	24						
NAC6024PVSBP	595	60	24						
NAC5424PVSBP	584	54	24						
NAC4824PVSBP	497	48	24						
NAC4224PVSBP	496	42	24						
NAC3624PVSBP	380	36	24						
NAC3024PVSBP	352	30	24						
NAC2724PVSBP	327	27	24						
NAC2424PVSBP	320	24	24						
NAC2124PVSBP	317	21	24						

- Quick Delivery Polycarbonate Set-On Screens feature Platinum Metallic brackets
- When ordering both back and side set-on screens, size down for side screens in order to avoid interference
- Clear rubber bumpers on bottom of brackets
- Clear U-Channel Edge Molding on all exposed edges
- Polycarbonate Thickness ¼"
- Foot dimension is 3" wide x 5" deep
- Semi-Opaque Reeded Polycarbonate
- Screen Metal Mounting Bracket
- Brackets ship in box with screen
- Remove protective film from screen
- Pressure fit screen into bracket and set in place
- Low level of complexity – can be installed by 1 person

# SET-ON SCREEN - DESKS+BENCHING

**TO ORDER, SPECIFY:**

1. Model Number
2. Resin Color
3. Bracket Paint Color

**SAMPLE MODEL NUMBER:**

- NAC7230PVSP  
 • See page 3 for Return To Work options

MODEL NO./DESCRIPTION	LIST PRICE	DIMENSIONS					CARTONED WEIGHT	CUBIC FEET
		D	W	H	A	KW		
<b>RESIN SET-ON SURFACE SCREEN</b>								
<b>¼" RESIN THICKNESS</b>								
<b>30" HIGH</b>								
NAC7230PVSP	\$ 1734		72	30				
NAC6630PVSP	1719		66	30				
NAC6030PVSP	1702		60	30				
NAC5430PVSP	1560		54	30				
NAC4830PVSP	936		48	30				
NAC4230PVSP	925		42	30				
NAC3630PVSP	826		36	30				
NAC3030PVSP	793		30	30				
NAC2730PVSP	646		27	30				
NAC2430PVSP	629		24	30				
NAC2130PVSP	596		21	30				
<b>24" HIGH</b>								
NAC7224PVSP	\$ 1236		72	24				
NAC6624PVSP	1222		66	24				
NAC6024PVSP	1207		60	24				
NAC5424PVSP	1158		54	24				
NAC4824PVSP	961		48	24				
NAC4224PVSP	765		42	24				
NAC3624PVSP	675		36	24				
NAC3024PVSP	658		30	24				
NAC2724PVSP	548		27	24				
NAC2424PVSP	537		24	24				
NAC2124PVSP	484		21	24				
<b>18" HIGH</b>								
NAC7218PVSP	\$ 817		72	18				
NAC6618PVSP	800		66	18				
NAC6018PVSP	784		60	18				
NAC5418PVSP	737		54	18				
NAC4818PVSP	598		48	18				
NAC4218PVSP	592		42	18				
NAC3618PVSP	514		36	18				
NAC3018PVSP	484		30	18				
NAC2718PVSP	448		27	18				
NAC2418PVSP	437		24	18				
NAC2118PVSP	418		21	18				



- When ordering both back and side set-on screens, size down for side screens in order to avoid interference
- Clear rubber bumpers on bottom of brackets
- Bulk pack pricing available – save money and reduce onsite packing materials by choosing this option. Contact our By Design Product Modifications Team for a price quote
- Resin Thickness ¼"
- Foot dimension is 3" wide x 5" deep
- Clear or Frosted Resin Screen
- Metal Mounting Bracket
- Brackets ship in box with screen
- Remove protective film from screen
- Pressure fit screen into bracket and set in place
- Medium complexity – 4 minutes, 2 people



# SET-ON SCREEN - DESKS+BENCHING

## TO ORDER, SPECIFY:

1. Model Number
2. Bracket Paint Color

## SAMPLE MODEL NUMBER:

NAC7230PVSPP

- See page 3 for Return To Work options

MODEL NO./DESCRIPTION	LIST PRICE	DIMENSIONS					CARTONED CUBIC WEIGHT	CUBIC FEET
		D	W	H	A	KW		
<b>PET SET-ON SURFACE SCREEN</b>								
<b>½" PET THICKNESS</b>								
<b>30" HIGH</b>								
NAC7230PVSPP	\$ 1593		72	30				
NAC6630PVSPP	1536		66	30				
NAC6030PVSPP	1502		60	30				
NAC5430PVSPP	1253		54	30				
NAC4830PVSPP	826		48	30				
NAC4230PVSPP	793		42	30				
NAC3630PVSPP	726		36	30				
NAC3030PVSPP	675		30	30				
NAC2730PVSPP	604		27	30				
NAC2430PVSPP	420		24	30				
NAC2130PVSPP	419		21	30				
<b>24" HIGH</b>								
NAC7224PVSPP	\$ 882		72	24				
NAC6624PVSPP	837		66	24				
NAC6024PVSPP	826		60	24				
NAC5424PVSPP	734		54	24				
NAC4824PVSPP	664		48	24				
NAC4224PVSPP	598		42	24				
NAC3624PVSPP	503		36	24				
NAC3024PVSPP	465		30	24				
NAC2724PVSPP	373		27	24				
NAC2424PVSPP	343		24	24				
NAC2124PVSPP	303		21	24				
<b>18" HIGH</b>								
NAC7218PVSPP	\$ 867		72	18				
NAC6618PVSPP	834		66	18				
NAC6018PVSPP	813		60	18				
NAC5418PVSPP	724		54	18				
NAC4818PVSPP	641		48	18				
NAC4218PVSPP	580		42	18				
NAC3618PVSPP	487		36	18				
NAC3018PVSPP	450		30	18				
NAC2718PVSPP	327		27	18				
NAC2418PVSPP	271		24	18				
NAC2118PVSPP	270		21	18				

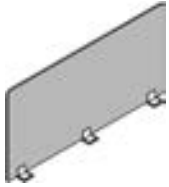

- When ordering both back and side set-on screens, size down for side screens in order to avoid interference
- Clear rubber bumpers on bottom of brackets
- PET Thickness ½"
- Foot dimension is 3" wide x 5" deep
- Nordic Knit PET Screen
- Metal Mounting Bracket
- Brackets ship in box with screen
- Remove protective film from screen
- Pressure fit screen into bracket and set in place
- Medium complexity – 4 minutes, 2 people

# CLAMP MOUNT SCREEN - DESKS+BENCHING



Shaded model numbers are available on our "To You in 10 Days or Less" Quick Delivery program and will be delivered in 10 days or less.

- Quick Delivery lead times applicable to orders of 20 screens or less

### TO ORDER, SPECIFY:

1. Model Number
2. Laminate Color
3. Clamp Paint Color

### SAMPLE MODEL NUMBERS:

QNAC7127PVC2405501  
NAC7127PVCC2LLP

- See page 3 for Return To Work options

	MODEL NO./DESCRIPTION	LIST PRICE	DIMENSIONS			CARTONED CUBIC		
			D	W	H	A	KW	WEIGHT
<b>TFL CLAMP MOUNT SCREEN</b> 	<b>½" TFL THICKNESS</b>							
	QNAC7127PVC2405501	\$ 868		71	27			
	QNAC6527PVC2405501	853		65	27			
	QNAC5927PVC2405501	809		59	27			
	QNAC5327PVC2405501	692		53	27			
	QNAC4727PVC2405501	666		47	27			
	QNAC2927PVC2405501	587		29	27			
	QNAC2327PVC2405501	560		23	27			

- Quick Delivery models feature Designer White Laminate and Platinum Metallic Clamps

### ½" TFL THICKNESS

NAC7127PVCC2LLP	\$ 868		71	27			
NAC6527PVCC2LLP	853		65	27			
NAC5927PVCC2LLP	809		59	27			
NAC5327PVCC2LLP	692		53	27			
NAC4727PVCC2LLP	666		47	27			
NAC2927PVCC2LLP	587		29	27			
NAC2327PVCC2LLP	560		23	27			

- Bulk pack pricing available – save money and reduce onsite packing materials by choosing this option. Contact our By Design Product Modifications Team for a price quote

- Above worksurface height is 24"
- Extends 3" below the worksurface
- Fits on ¾" – 1½" worksurface thicknesses
- Grain direction is always Horizontal
- Size down to avoid pinch points on height adjust worksurfaces, as well as when both front and side screens are specified
- Clamp is plastic with a non-marring foam
- TFL Thickness ½"
- Above surface height is 24"
- TFL Panel
- Metal Clamp
- Brackets ship attached to screen
- Tighten thumb screw to secure to surface
- Low level of complexity – can be installed by 1 person

## CLAMP MOUNT SCREEN - DESKS+BENCHING

### TO ORDER, SPECIFY:

1. Model Number
2. Laminate Color
3. Clamp Paint Color

### SAMPLE MODEL NUMBER:

NAC7127PVCC2P

- See page 3 for Return To Work options

MODEL NO./DESCRIPTION	LIST PRICE	DIMENSIONS				CARTONED WEIGHT	CUBIC FEET
		D	W	H	A		
<b>RESIN CLAMP MOUNT SCREEN</b>							
<b>¾" RESIN THICKNESS</b>							
NAC7127PVCC2P	\$ 1460		71	27			
NAC6527PVCC2P	1437		65	27			
NAC5927PVCC2P	1418		59	27			
NAC5327PVCC2P	1047		53	27			
NAC4727PVCC2P	938		47	27			
NAC2927PVCC2P	832		29	27			
NAC2327PVCC2P	644		23	27			

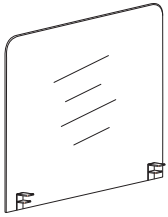

- Size down to avoid pinch points on height adjust worksurfaces, as well as when both front and side screens are specified
- Fits on ¾" - 1 1/8" worksurface thicknesses
- Screen extends 24" above worksurface
- Extends 3" Below Worksurface
- Clamp is plastic with a non-marring foam
- Bulk pack pricing available – save money and reduce onsite packing materials by choosing this option. Contact our By Design Product Modifications Team for a price quote
- Resin Thickness ¾"
- Clear or Frosted Resin Screen
- Metal Clamp
- Brackets ship attached to screen
- Tighten thumb screw to secure to surface
- Easy to install - can be installed by 1 person

# EDGE MOUNT SCREEN - DESKS+BENCHING



Shaded model numbers are available on our "To You in 10 Days or Less" Quick Delivery program and will be delivered in 10 days or less.

- Quick Delivery lead times applicable to orders of 20 screens or less

### TO ORDER, SPECIFY:

1. Model Number

### SAMPLE MODEL NUMBER:

NAC7240PVCBP

- See page 3 for Return To Work options

POLYCARBONATE EDGE MOUNT SURFACE SCREEN	MODEL NO./DESCRIPTION	LIST PRICE	DIMENSIONS			CARTONED CUBIC WEIGHT FEET
			D	W	H	
	<b>¼" POLYCARBONATE THICKNESS 40" HIGH</b>					<b>ABOVE WORKSURFACE H</b>
	NAC7240PVCBP	\$ 505	72	40	34	
	NAC6640PVCBP	495	66	40	34	
	NAC6040PVCBP	483	60	40	34	
	NAC5440PVCBP	474	54	40	34	
	NAC4840PVCBP	462	48	40	34	
	NAC4240PVCBP	452	42	40	34	
	NAC3640PVCBP	420	36	40	34	
	NAC3040PVCBP	314	30	40	34	
	NAC2740PVCBP	284	27	40	34	
	NAC2440PVCBP	271	24	40	34	
	NAC2140PVCBP	264	21	40	34	
	<b>30" HIGH</b>					
NAC7230PVCBP	\$ 429	72	30	24		
NAC6630PVCBP	422	66	30	24		
NAC6030PVCBP	414	60	30	24		
NAC5430PVCBP	405	54	30	24		
NAC4830PVCBP	396	48	30	24		
NAC4230PVCBP	388	42	30	24		
NAC3630PVCBP	356	36	30	24		
NAC3030PVCBP	276	30	30	24		
NAC2730PVCBP	272	27	30	24		
NAC2430PVCBP	244	24	30	24		
NAC2130PVCBP	239	21	30	24		
	<b>24" HIGH</b>					
NAC7224PVCBP	\$ 386	72	24	18		
NAC6624PVCBP	380	66	24	18		
NAC6024PVCBP	371	60	24	18		
NAC5424PVCBP	365	54	24	18		
NAC4824PVCBP	355	48	24	18		
NAC4224PVCBP	349	42	24	18		
NAC3624PVCBP	263	36	24	18		
NAC3024PVCBP	254	30	24	18		
NAC2724PVCBP	251	27	24	18		
NAC2424PVCBP	230	24	24	18		
NAC2124PVCBP	222	21	24	18		

- Quick Delivery Screens will feature Platinum Metallic mounting brackets. Specify bracket application
- Screen extends 4" below worksurface
- Clear U-Channel edge molding attached on all sides of screen
- Fits on 1½" - 1¾" worksurface thicknesses
- Polycarbonate Thickness ¼"
- Semi-Opaque Reeded Polycarbonate Screen
- Metal Mounting Bracket
- When ordering both back and side edge mount screens, size down for side screens to avoid interference
- Brackets ship in box with screen
- Remove protective film from screen
- Edge Mount Privacy Panel faceplate can be installed horizontally or vertically
- Will require attachment to surface with fasteners - 2 people recommended for installation

# EDGE MOUNT SCREEN - DESKS+BENCHING

**TO ORDER, SPECIFY:**

1. Model Number
2. Bracket Application
3. Resin Color
4. Bracket Paint Color

**SAMPLE MODEL NUMBER:**

NAC7240PVCP

- See page 3 for Return To Work options

**RESIN EDGE MOUNT SURFACE SCREEN**



MODEL NO./DESCRIPTION	LIST PRICE	DIMENSIONS			CARTONED WEIGHT	CUBIC FEET
		D	W	H		
<b>¼" RESIN THICKNESS</b>						
<b>40" HIGH</b>						
NAC7240PVCP	\$ 1265		72	40	34	
NAC6640PVCP	1251		66	40	34	
NAC6040PVCP	1090		60	40	34	
NAC5440PVCP	1077		54	40	34	
NAC4840PVCP	1037		48	40	34	
NAC4240PVCP	1026		42	40	34	
NAC3640PVCP	717		36	40	34	
NAC3040PVCP	630		30	40	34	
NAC2740PVCP	623		27	40	34	
NAC2440PVCP	541		24	40	34	
NAC2140PVCP	534		21	40	34	
<b>30" HIGH</b>						
NAC7230PVCP	\$ 983		72	30	24	
NAC6630PVCP	978		66	30	24	
NAC6030PVCP	858		60	30	24	
NAC5430PVCP	849		54	30	24	
NAC4830PVCP	759		48	30	24	
NAC4230PVCP	750		42	30	24	
NAC3630PVCP	574		36	30	24	
NAC3030PVCP	537		30	30	24	
NAC2730PVCP	531		27	30	24	
NAC2430PVCP	444		24	30	24	
NAC2130PVCP	439		21	30	24	
<b>24" HIGH</b>						
NAC7224PVCP	\$ 664		72	24	18	
NAC6624PVCP	661		66	24	18	
NAC6024PVCP	484		60	24	18	
NAC5424PVCP	474		54	24	18	
NAC4824PVCP	416		48	24	18	
NAC4224PVCP	441		42	24	18	
NAC3624PVCP	339		36	24	18	
NAC3024PVCP	319		30	24	18	
NAC2724PVCP	315		27	24	18	
NAC2424PVCP	287		24	24	18	
NAC2124PVCP	284		21	24	18	

- Screen extends 4" below worksurface
- Resin available in Clear or Frosted with radiused corners
- Fits on 1<sup>3</sup>/<sub>8</sub>" - 1<sup>7</sup>/<sub>8</sub>" worksurface thicknesses
- Bulk pack pricing available - save money and reduce onsite packing materials by choosing this option. Contact our By Design Product Modifications Team for a price quote
- Resin Thickness ¼"
- Clear or Frosted Resin Screen
- Metal Mounting Bracket
- When ordering both back and side edge mount screens, size down for side screens to avoid interface
- Brackets ship in box with screen
- Remove protective film from screen
- Edge Mount Privacy Panel faceplate can be installed horizontally or vertically
- Will require attachment to surface with fasteners - 2 people recommended for installation

# EDGE MOUNT SCREEN - DESKS+BENCHING

## TO ORDER, SPECIFY:

1. Model Number
2. Bracket Application
3. Bracket Paint Color

## SAMPLE MODEL NUMBER:

NAC7240PVCPP

- See page 3 for Return To Work options

MODEL NO./DESCRIPTION	LIST PRICE	DIMENSIONS			CARTONED WEIGHT	CUBIC FEET
		D	W	H		
<b>PET EDGE MOUNT SCREEN</b>						
<b>½" PET THICKNESS 40" HIGH</b>						<b>ABOVE WORKSURFACE H</b>
NAC7240PVCPP	\$ 1609	72	40	34		
NAC6640PVCPP	1543	66	40	34		
NAC6040PVCPP	1513	60	40	34		
NAC5440PVCPP	1272	54	40	34		
NAC4840PVCPP	1150	48	40	34		
NAC4240PVCPP	1051	42	40	34		
NAC3640PVCPP	1041	36	40	34		
NAC3040PVCPP	784	30	40	34		
NAC2740PVCPP	634	27	40	34		
NAC2440PVCPP	567	24	40	34		
NAC2140PVCPP	490	21	40	34		
<b>30" HIGH</b>						
NAC7230PVCPP	\$ 1592	72	30	24		
NAC6630PVCPP	1528	66	30	24		
NAC6030PVCPP	1499	60	30	24		
NAC5430PVCPP	1253	54	30	24		
NAC4830PVCPP	965	48	30	24		
NAC4230PVCPP	824	42	30	24		
NAC3630PVCPP	784	36	30	24		
NAC3030PVCPP	758	30	30	24		
NAC2730PVCPP	539	27	30	24		
NAC2430PVCPP	415	24	30	24		
NAC2130PVCPP	413	21	30	24		
<b>24" HIGH</b>						
NAC7224PVCPP	\$ 875	72	24	18		
NAC6624PVCPP	843	66	24	18		
NAC6024PVCPP	820	60	24	18		
NAC5424PVCPP	724	54	24	18		
NAC4824PVCPP	656	48	24	18		
NAC4224PVCPP	590	42	24	18		
NAC3624PVCPP	494	36	24	18		
NAC3024PVCPP	455	30	24	18		
NAC2724PVCPP	393	27	24	18		
NAC2424PVCPP	373	24	24	18		
NAC2124PVCPP	343	21	24	18		



- Screen extends 4" below worksurface
- PET Screen with radiused corners
- Fits on 1<sup>1</sup>/<sub>16</sub>" - 1<sup>3</sup>/<sub>16</sub>" worksurface thicknesses
- PET Thickness ½"
- Nordic Knit PET Screen
- Metal Mounting Bracket
- When ordering both back and side edge mount screens, size down for side screens to avoid interface
- Brackets ship in box with screen
- Remove protective film from screen
- Edge Mount Privacy Panel faceplate can be installed horizontally or vertically
- Will require attachment to surface with fasteners - 2 people recommended for installation

# EDGE MOUNT SCREEN - DESKS+BENCHING

## TO ORDER, SPECIFY:

1. Model Number
2. Bracket Application
3. Textile Grade / Color
4. Bracket Paint Color

## SAMPLE MODEL NUMBER:

NAC7240PVC2PFA

- See page 3 for Return To Work options

### VERTICAL TEXTILE EDGE MOUNT SCREEN



MODEL NO./DESCRIPTION	LIST PRICE	DIMENSIONS	D	W	H	A	KW	CARTONED WEIGHT	CUBIC FEET
<b>1" TEXTILE SCREEN THICKNESS</b>									
<b>40" HIGH</b>									
NAC7240PVC2PFA	\$ 1687	\$ 1874		72	40	34			
NAC6640PVC2PFA	1595	1767		66	40	34			
NAC6040PVC2PFA	1485	1643		60	40	34			
NAC5440PVC2PFA	1382	1525		54	40	34			
NAC4840PVC2PFA	1273	1401		48	40	34			
NAC4240PVC2PFA	1196	1310		42	40	34			
NAC3640PVC2PFA	1097	1196		36	40	34			
NAC3040PVC2PFA	993	1077		30	40	34			
NAC2740PVC2PFA	942	1019		27	40	34			
NAC2440PVC2PFA	858	928		24	40	34			
NAC2140PVC2PFA	820	882		21	40	34			
<b>30" HIGH</b>									
NAC7230PVC2PFA	\$ 1443	\$ 1630		72	30	24			
NAC6630PVC2PFA	1355	1527		66	30	24			
NAC6030PVC2PFA	1268	1426		60	30	24			
NAC5430PVC2PFA	1178	1321		54	30	24			
NAC4830PVC2PFA	1090	1218		48	30	24			
NAC4230PVC2PFA	1003	1117		42	30	24			
NAC3630PVC2PFA	913	1012		36	30	24			
NAC3030PVC2PFA	827	911		30	30	24			
NAC2730PVC2PFA	779	856		27	30	24			
NAC2430PVC2PFA	672	742		24	30	24			
NAC2130PVC2PFA	640	702		21	30	24			
<b>24" HIGH</b>									
NAC7224PVC2PFA	\$ 1148	\$ 1247		72	24	18			
NAC6624PVC2PFA	1089	1177		66	24	18			
NAC6024PVC2PFA	1030	1118		60	24	18			
NAC5424PVC2PFA	963	1040		54	24	18			
NAC4824PVC2PFA	900	966		48	24	18			
NAC4224PVC2PFA	843	909		42	24	18			
NAC3624PVC2PFA	756	811		36	24	18			
NAC3024PVC2PFA	697	741		30	24	18			
NAC2724PVC2PFA	663	707		27	24	18			
NAC2424PVC2PFA	626	670		24	24	18			
NAC2124PVC2PFA	590	623		21	24	18			

- Screen extends 4" below worksurface
- PET Screen with radiused corners
- Fits on 1 1/8" - 1 3/8" worksurface thicknesses
- Textile Screen Thickness 1"
- Metal Mounting Bracket
- When ordering both back and side edge mount screens, size down for side screens to avoid interface
- Brackets ship in box with screen
- Remove protective film from screen
- Edge Mount Privacy Panel faceplate can be installed horizontally or vertically
- Will require attachment to surface with fasteners - 2 people recommended for installation

# EDGE MOUNT SCREEN/MODESTY - DESKS+BENCHING



Shaded model numbers are available on our "To You in 10 Days or Less" Quick Delivery program and will be delivered in 10 days or less.

- Quick Delivery lead times applicable to orders of 20 screens or less

### TO ORDER, SPECIFY:

1. Model Number

### SAMPLE MODEL NUMBER:

NAC7244PVMCBP

- See page 3 for Return To Work options

POLYCARBONATE EDGE MOUNT SURFACE SCREEN/MODESTY	MODEL NO./DESCRIPTION	LIST PRICE	DIMENSIONS			CARTONED CUBIC	
			D	W	H	A	KW
	<b>¼" POLYCARBONATE THICKNESS 44" HIGH</b>						<b>ABOVE WORKSURFACE H</b>
	NAC7244PVMCBP	\$ 1179	72	44	30		
	NAC6644PVMCBP	1177	66	44	30		
	NAC6044PVMCBP	818	60	44	30		
	NAC5444PVMCBP	817	54	44	30		
	NAC4844PVMCBP	710	48	44	30		
	NAC4244PVMCBP	705	42	44	30		
	NAC3644PVMCBP	683	36	44	30		
	NAC3044PVMCBP	509	30	44	30		
	NAC2744PVMCBP	507	27	44	30		
	NAC2444PVMCBP	454	24	44	30		
	NAC2144PVMCBP	452	21	44	30		
	<b>38" HIGH</b>						
NAC7238PVMCBP	\$ 1172	72	38	24			
NAC6638PVMCBP	1169	66	38	24			
NAC6038PVMCBP	809	60	38	24			
NAC5438PVMCBP	807	54	38	24			
NAC4838PVMCBP	701	48	38	24			
NAC4238PVMCBP	697	42	38	24			
NAC3638PVMCBP	675	36	38	24			
NAC3038PVMCBP	504	30	38	24			
NAC2738PVMCBP	499	27	38	24			
NAC2438PVMCBP	448	24	38	24			
NAC2138PVMCBP	447	21	38	24			
	<b>32" HIGH</b>						
NAC7232PVMCBP	\$ 482	72	32	18			
NAC6632PVMCBP	480	66	32	18			
NAC6032PVMCBP	455	60	32	18			
NAC5432PVMCBP	454	54	32	18			
NAC4832PVMCBP	450	48	32	18			
NAC4232PVMCBP	447	42	32	18			
NAC3632PVMCBP	329	36	32	18			
NAC3032PVMCBP	322	30	32	18			
NAC2732PVMCBP	320	27	32	18			
NAC2432PVMCBP	287	24	32	18			
NAC2132PVMCBP	286	21	32	18			

- Quick Delivery Screens will feature Platinum Metallic mounting brackets. Specify bracket application
- Screen extends 12" below worksurface
- Clear U-Channel edge molding attached on all sides of screen
- Fits on 1½" - 1¾" worksurface thicknesses
- Polycarbonate Thickness ¼"
- Semi-Opaque Reeded Polycarbonate Screen
- Metal Mounting Bracket
- When ordering both back and side edge mount screens, size down for side screens to avoid interference
- Brackets ship in box with screen
- Remove protective film from screen
- Edge Mount Privacy Panel faceplate can be installed horizontally or vertically
- Will require attachment to surface with fasteners - 2 people recommended for installation



# EDGE MOUNT SCREEN/MODESTY - DESKS+BENCHING

**TO ORDER, SPECIFY:**

1. Model Number
2. Bracket Application
3. Resin Color
4. Bracket Paint Color

**SAMPLE MODEL NUMBER:**

NAC7244PVMCP

- See page 3 for Return To Work options

**RESIN EDGE MOUNT  
SURFACE SCREEN/MODESTY**

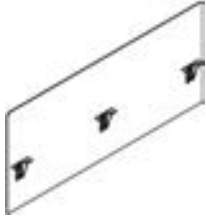

MODEL NO./DESCRIPTION	LIST PRICE	DIMENSIONS			CARTONED WEIGHT	CUBIC FEET
		D	W	H		
<b>¼" RESIN THICKNESS</b>						
<b>44" HIGH</b>						
NAC7244PVMCP	\$ 1667	72	44	30		
NAC6644PVMCP	1661	66	44	30		
NAC6044PVMCP	1408	60	44	30		
NAC5444PVMCP	1406	54	44	30		
NAC4844PVMCP	1001	48	44	30		
NAC4244PVMCP	994	42	44	30		
NAC3644PVMCP	922	36	44	30		
NAC3044PVMCP	725	30	44	30		
NAC2744PVMCP	722	27	44	30		
NAC2444PVMCP	598	24	44	30		
NAC2144PVMCP	595	21	44	30		
<b>38" HIGH</b>						
NAC7238PVMCP	\$ 1196	72	38	24		
NAC6638PVMCP	1190	66	38	24		
NAC6038PVMCP	1015	60	38	24		
NAC5438PVMCP	1013	54	38	24		
NAC4838PVMCP	983	48	38	24		
NAC4238PVMCP	978	42	38	24		
NAC3638PVMCP	683	36	38	24		
NAC3038PVMCP	604	30	38	24		
NAC2738PVMCP	600	27	38	24		
NAC2438PVMCP	523	24	38	24		
NAC2138PVMCP	521	21	38	24		
<b>32" HIGH</b>						
NAC7232PVMCP	\$ 1166	72	32	18		
NAC6632PVMCP	1163	66	32	18		
NAC6032PVMCP	794	60	32	18		
NAC5432PVMCP	790	54	32	18		
NAC4832PVMCP	760	48	32	18		
NAC4232PVMCP	693	42	32	18		
NAC3632PVMCP	663	36	32	18		
NAC3032PVMCP	503	30	32	18		
NAC2732PVMCP	486	27	32	18		
NAC2432PVMCP	452	24	32	18		
NAC2132PVMCP	439	21	32	18		

- Screen extends 12" below worksurface
- Resin available in Clear or Frosted with radiused corners
- Fits on 1<sup>3</sup>/<sub>8</sub>" - 1<sup>7</sup>/<sub>8</sub>" worksurface thicknesses
- Bulk pack pricing available - save money and reduce onsite packing materials by choosing this option. Contact our By Design Product Modifications Team for a price quote
- Resin Thickness ¼"
- Clear or Frosted Resin Screen
- Metal Mounting Bracket
- When ordering both back and side edge mount screens, size down for side screens to avoid interface
- Brackets ship in box with screen
- Remove protective film from screen
- Edge Mount Privacy Panel faceplate can be installed horizontally or vertically
- Will require attachment to surface with fasteners - 2 people recommended for installation

# EDGE MOUNT SCREEN/MODESTY - DESKS+BENCHING

## TO ORDER, SPECIFY:

1. Model Number
2. Bracket Application
3. Bracket Paint Color

## SAMPLE MODEL NUMBER:

NAC7244PVMCPP

- See page 3 for Return To Work options

MODEL NO./DESCRIPTION	LIST PRICE	DIMENSIONS			CARTONED CUBIC			
		D	W	H	A	KW	WEIGHT	FEET
<b>PET EDGE MOUNT SURFACE SCREEN/MODESTY SCREEN</b>								
<b>½" PET THICKNESS 44" HIGH</b>					<b>ABOVE WORKSURFACE H</b>			
NAC7244PVMCPP	\$ 1609	72	44	30				
NAC6644PVMCPP	1549	66	44	30				
NAC6044PVMCPP	1525	60	44	30				
NAC5444PVMCPP	1285	54	44	30				
NAC4844PVMCPP	1156	48	44	30				
NAC4244PVMCPP	1065	42	44	30				
NAC3644PVMCPP	1055	36	44	30				
NAC3044PVMCPP	788	30	44	30				
NAC2744PVMCPP	647	27	44	30				
NAC2444PVMCPP	572	24	44	30				
NAC2144PVMCPP	499	21	44	30				
<b>38" HIGH</b>								
NAC7238PVMCPP	\$ 1604	72	38	24				
NAC6638PVMCPP	1541	66	38	24				
NAC6038PVMCPP	1510	60	38	24				
NAC5438PVMCPP	1267	54	38	24				
NAC4838PVMCPP	1146	48	38	24				
NAC4238PVMCPP	1041	42	38	24				
NAC3638PVMCPP	1025	36	38	24				
NAC3038PVMCPP	774	30	38	24				
NAC2738PVMCPP	611	27	38	24				
NAC2438PVMCPP	559	24	38	24				
NAC2138PVMCPP	482	21	38	24				
<b>32" HIGH</b>								
NAC7232PVMCPP	\$ 1597	72	32	18				
NAC6632PVMCPP	1532	66	32	18				
NAC6032PVMCPP	1507	60	32	18				
NAC5432PVMCPP	1258	54	32	18				
NAC4832PVMCPP	987	48	32	18				
NAC4232PVMCPP	845	42	32	18				
NAC3632PVMCPP	799	36	32	18				
NAC3032PVMCPP	769	30	32	18				
NAC2732PVMCPP	549	27	32	18				
NAC2432PVMCPP	421	24	32	18				
NAC2132PVMCPP	420	21	32	18				

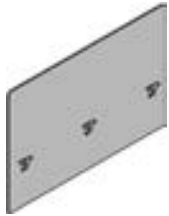

- Screen extends 12" below worksurface
- PET Screen with radiused corners
- Fits on 1 1/8" - 1 1/16" worksurface thicknesses
- PET Thickness ½"
- Nordic Knit PET Screen
- Metal Mounting Bracket
- When ordering both back and side edge mount screens, size down for side screens to avoid interface
- Brackets ship in box with screen
- Remove protective film from screen
- Edge Mount Privacy Panel faceplate can be installed horizontally or vertically
- Will require attachment to surface with fasteners - 2 people recommended for installation

# EDGE MOUNT SCREEN/MODESTY - DESKS+BENCHING

**TO ORDER, SPECIFY:**

1. Model Number
2. Bracket Application
3. Textile Grade / Color
4. Bracket Paint Color

**SAMPLE MODEL NUMBER:**

NAC7244PVMC2PFA

- See page 3 for Return To Work options

**VERTICAL TEXTILE  
EDGE MOUNT SURFACE  
SCREEN/MODESTY SCREEN**

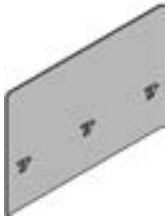

MODEL NO./DESCRIPTION	LIST PRICE	DIMENSIONS			CARTONED WEIGHT	CUBIC FEET
		D	W	H		
<b>1" TEXTILE SCREEN THICKNESS 44" HIGH</b>						
NAC7244PVMC2PFA	\$ 1599	\$ 1786	72	44	30	
NAC6644PVMC2PFA	1506	1678	66	44	30	
NAC6044PVMC2PFA	1395	1553	60	44	30	
NAC5444PVMC2PFA	1299	1442	54	44	30	
NAC4844PVMC2PFA	1202	1330	48	44	30	
NAC4244PVMC2PFA	1113	1227	42	44	30	
NAC3644PVMC2PFA	1014	1113	36	44	30	
NAC3044PVMC2PFA	921	1005	30	44	30	
NAC2744PVMC2PFA	867	944	27	44	30	
NAC2444PVMC2PFA	798	868	24	44	30	
NAC2144PVMC2PFA	762	824	21	44	30	
<b>38" HIGH</b>						
NAC7238PVMC2PFA	\$ 1540	\$ 1727	72	38	24	
NAC6638PVMC2PFA	1443	1615	66	38	24	
NAC6038PVMC2PFA	1334	1492	60	38	24	
NAC5438PVMC2PFA	1246	1389	54	38	24	
NAC4838PVMC2PFA	1150	1278	48	38	24	
NAC4238PVMC2PFA	1063	1177	42	38	24	
NAC3638PVMC2PFA	972	1071	36	38	24	
NAC3038PVMC2PFA	877	961	30	38	24	
NAC2738PVMC2PFA	829	906	27	38	24	
NAC2438PVMC2PFA	744	814	24	38	24	
NAC2138PVMC2PFA	710	772	21	38	24	
<b>32" HIGH</b>						
NAC7232PVMC2PFA	\$ 1609	\$ 1796	72	32	18	
NAC6632PVMC2PFA	1511	1687	66	32	18	
NAC6032PVMC2PFA	1401	1559	60	32	18	
NAC5432PVMC2PFA	1308	1451	54	32	18	
NAC4832PVMC2PFA	1207	1339	48	32	18	
NAC4232PVMC2PFA	1114	1228	42	32	18	
NAC3632PVMC2PFA	997	1096	36	32	18	
NAC3032PVMC2PFA	904	992	30	32	18	
NAC2732PVMC2PFA	854	931	27	32	18	
NAC2432PVMC2PFA	754	831	24	32	18	
NAC2132PVMC2PFA	719	785	21	32	18	

- Screen extends 12" below worksurface
- Vertical Textile Screen with radiused corners
- Fits on 1 1/8" - 1 3/8" worksurface thicknesses
- Textile Screen Thickness 1"
- Metal Mounting Bracket
- When ordering both back and side edge mount screens, size down for side screens to avoid interface
- Brackets ship in box with screen
- Remove protective film from screen
- Edge Mount Privacy Panel faceplate can be installed horizontally or vertically
- Will require attachment to surface with fasteners - 2 people recommended for installation

# FULL EDGE MOUNT SCREEN - DESKS+BENCHING

**TO ORDER, SPECIFY:**

1. Model Number
2. Bracket Paint Color

**SAMPLE MODEL NUMBER:**

NAC7224PVEGP

- See page 3 for Return To Work options

MODEL NO./DESCRIPTION	LIST PRICE	DIMENSIONS					CARTONED CUBIC	
		D	W	H	A	KW	WEIGHT	FEET
<b>GLASS FULL EDGE MOUNT SCREEN</b>								
<b>¼" GLASS THICKNESS</b>								
<b>24" HIGH</b>								
NAC7224PVEGP	\$ 664		72	24				
NAC6624PVEGP	622		66	24				
NAC6024PVEGP	583		60	24				
NAC5424PVEGP	538		54	24				
NAC4824PVEGP	503		48	24				
NAC2924PVSEGP	394		29	24				
NAC2324PVSEGP	353		23	24				



- Screen extends 24" above worksurface
- Size down to avoid pinch points on height adjust surfaces, as well as when both front and side screens are specified
- Fits on 1<sup>3</sup>/<sub>16</sub>" and 1<sup>7</sup>/<sub>16</sub>" worksurface thicknesses
- Bulk pack pricing available – save money and reduce onsite packing materials by choosing this option. Contact our By Design Product Modifications Team for a price quote
- Glass Thickness ¼"
- Clear Tempered Glass Screen
- Metal Edge Bracket
- Bracket ships attached to screen
- Secure under surface with screws
- Remove protective film from screen
- Attaches to the underneath side of the worksurface with fasteners – 2 people recommended for installation

## FULL EDGE MOUNT SCREEN - DESKS+BENCHING

**TO ORDER, SPECIFY:**

1. Model Number
2. Resin Color
3. Bracket Paint Color

**SAMPLE MODEL NUMBER:**

- NAC7224PVEP  
 • See page 3 for Return To Work options

	MODEL NO./DESCRIPTION	LIST PRICE	DIMENSIONS				CARTONED WEIGHT	CUBIC FEET
			D	W	H	A		
	<b>¼" RESIN THICKNESS 24" HIGH</b>							
	NAC7224PVEP	\$ 1047		72	24			
	NAC6624PVEP	913		66	24			
	NAC6024PVEP	754		60	24			
	NAC5424PVEP	745		54	24			
	NAC4824PVEP	733		48	24			
	NAC2924PVSEP	444		29	24			
	NAC2324PVSEP	370		23	24			

- Screen extends 24" above worksurface
- Size down to avoid pinch points on height adjust surfaces, as well as when both front and side screens are specified
- Fits on 1¾" and 1⅞" worksurface thicknesses
- Bulk pack pricing available – save money and reduce onsite packing materials by choosing this option. Contact our By Design Product Modifications Team for a price quote
- Resin Thickness ¼"
- Clear or Frosted Resin Screen
- Metal Edge Bracket
- Bracket ships attached to screen
- Secure under surface with screws
- Remove protective film from screen
- Attaches to the underneath side of the worksurface with fasteners – 2 people recommended for installation

# FULL EDGE MOUNT SCREEN - DESKS+BENCHING

**TO ORDER, SPECIFY:**

1. Model Number
2. Bracket Paint Color

**SAMPLE MODEL NUMBER:**

NAC7230PVEPP

- See page 3 for Return To Work options

MODEL NO./DESCRIPTION	LIST PRICE	DIMENSIONS					CARTONED WEIGHT	CUBIC FEET
		D	W	H	A	KW		
<b>PET FULL EDGE MOUNT SCREEN</b>								
<b>½" PET THICKNESS</b>								
<b>30" HIGH</b>								
NAC7230PVEPP	\$ 1728		72	30				
NAC6630PVEPP	1635		66	30				
NAC6030PVEPP	1569		60	30				
NAC5430PVEPP	1213		54	30				
NAC4830PVEPP	853		48	30				
NAC2930PVSEPP	766		29	30				
NAC2330PVSEPP	648		23	30				
<b>24" HIGH</b>								
NAC7224PVEPP	\$ 1000		72	24				
NAC6624PVEPP	953		66	24				
NAC6024PVEPP	908		60	24				
NAC5424PVEPP	818		54	24				
NAC4824PVEPP	702		48	24				
NAC2924PVSEPP	496		29	24				
NAC2324PVSEPP	382		23	24				

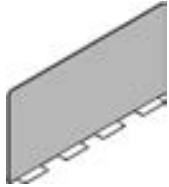

- 24"H Screen extends 24" above worksurface; 30"H Screen extends 30" above worksurface
- Size down to avoid pinch points on height adjust surfaces, as well as when both front and side screens are specified
- Fits on 1¾" and 1⅞" worksurface thicknesses
- PET Thickness ½"
- Nordic Knit PET Screen
- Metal Edge Bracket
- Bracket ships attached to screen
- Secure under surface with screws
- Remove protective film from screen
- Attaches to the underneath side of the worksurface with fasteners – 2 people recommended for installation

## STATIC FLOOR SCREEN - DESKS+BENCHING

### TO ORDER, SPECIFY:

1. Model Number
2. Frame Paint Color

### SAMPLE MODEL NUMBERS:

NAC4872FLSGP  
NAC4872FLSBP

- See page 3 for Return To Work options

MODEL NO./DESCRIPTION	LIST PRICE	DIMENSIONS				CARTONED WEIGHT	CUBIC FEET
		D	W	H	A KW		
<b>GLASS STATIC FLOOR SCREEN</b>							
<b>1½" X 1½" FRAME THICKNESS</b>							
<b>72" HIGH</b>							
NAC4872FLSGP	\$ 2072	18	48	72			
NAC3672FLSGP	1668	18	36	72			
NAC3072FLSGP	1572	18	30	72			
NAC2472FLSGP	1459	18	24	72			
<b>60" HIGH</b>							
NAC4860FLSGP	\$ 1857	18	48	60			
NAC3660FLSGP	1662	18	36	60			
NAC3060FLSGP	1465	18	30	60			
NAC2460FLSGP	1372	18	24	60			
<ul style="list-style-type: none"> <li>• Clear Glass</li> <li>• Aluminum frame with flat metal feet</li> <li>• Clear rubber bumpers on feet</li> <li>• Bulk pack pricing available – save money and reduce onsite packing materials by choosing this option. Contact our By Design Product Modifications Team for a price quote</li> <li>• Frame Thickness 1½" x 1½"</li> <li>• 60" High Frame has Foot Dimensions of 18" deep x 4" wide</li> <li>• 72" High Frame has Foot Dimensions 19½" deep x 4" wide</li> <li>• Clear Tempered Glass Screen</li> <li>• Aluminum Painted Frame</li> <li>• Feet ship in box with screen unattached</li> <li>• Attach feet with screwdriver</li> <li>• 2 people recommended for installation</li> </ul>							



### FLUTED POLYCARBONATE STATIC FLOOR SCREEN



<b>1½" X 1½" FRAME THICKNESS</b>							
<b>72" HIGH</b>							
NAC4872FLSBP	\$ 1795	18	48	72			
NAC3672FLSBP	1445	18	36	72			
NAC3072FLSBP	1409	18	30	72			
NAC2472FLSBP	1299	18	24	72			
<b>60" HIGH</b>							
NAC4860FLSBP	\$ 1609	18	48	60			
NAC3660FLSBP	1464	18	36	60			
NAC3060FLSBP	1322	18	30	60			
NAC2460FLSBP	1228	18	24	60			
<ul style="list-style-type: none"> <li>• Semi-opaque fluted polycarbonate</li> <li>• Aluminum frame with flat metal feet</li> <li>• Clear rubber bumpers on feet</li> <li>• Bulk pack pricing available – save money and reduce onsite packing materials by choosing this option. Contact our By Design Product Modifications Team for a price quote</li> <li>• Frame Thickness 1½" x 1½"</li> <li>• 60" High Frame has Foot Dimensions of 18" deep x 4" wide</li> <li>• 72" High Frame has Foot Dimensions 19½" deep x 4" wide</li> <li>• Fluted, Semi-Opaque Polycarbonate Screen</li> <li>• Aluminum Painted Frame</li> <li>• Feet ship in box with screen unattached</li> <li>• Attach feet with screwdriver</li> <li>• 2 people recommended for installation</li> </ul>							

# STATIC FLOOR SCREEN - DESKS+BENCHING

**TO ORDER, SPECIFY:**

1. Model Number
2. HPL Color
3. Frame Paint Color

**SAMPLE MODEL NUMBER:**

- NAC4872FLSGP  
 • See page 3 for Return To Work options

MODEL NO./DESCRIPTION	LIST PRICE	DIMENSIONS			A	KW	CARTONED WEIGHT	CUBIC FEET
		D	W	H				
<b>HPL STATIC FLOOR SCREEN</b>								
<b>1½" X 1½" FRAME THICKNESS</b>								
<b>72" HIGH</b>								
NAC4872FLSLP	\$ 2203	18	48	72				
NAC3672FLSLP	1936	18	36	72				
NAC3072FLSLP	1784	18	30	72				
NAC2472FLSLP	1620	18	24	72				
<b>60" HIGH</b>								
NAC4860FLSLP	\$ 1991	18	48	60				
NAC3660FLSLP	1810	18	36	60				
NAC3060FLSLP	1628	18	30	60				
NAC2460FLSLP	1494	18	24	60				



- HPL
- Aluminum frame with flat metal feet
- Clear rubber bumpers on feet
- Bulk pack pricing available – save money and reduce onsite packing materials by choosing this option. Contact our By Design Product Modifications Team for a price quote
- Frame Thickness 1½" x 1½"
- 60" High Frame has Foot Dimensions of 18" deep x 4" wide
- 72" High Frame has Foot Dimensions 19½" deep x 4" wide
- HPL Screen
- Aluminum Painted Frame
- Feet ship in box with screen unattached
- Attach feet with screwdriver
- 2 people recommended for installation



## STATIC FLOOR SCREEN - DESKS+BENCHING

### TO ORDER, SPECIFY:

1. Model Number
2. Frame Paint Color

### SAMPLE MODEL NUMBERS:

NAC4872FLSMP  
NAC4872FLSPP

- See page 3 for Return To Work options

### HPL MARKER BOARD STATIC FLOOR SCREEN



MODEL NO./DESCRIPTION	LIST PRICE	DIMENSIONS				CARTONED WEIGHT	CUBIC FEET
		D	W	H	A KW		
<b>1½" X 1½" FRAME THICKNESS 72" HIGH</b>							
NAC4872FLSMP	\$ 2203	18	48	72			
NAC3672FLSMP	1936	18	36	72			
NAC3072FLSMP	1784	18	30	72			
NAC2472FLSMP	1620	18	24	72			
<b>60" HIGH</b>							
NAC4860FLSMP	\$ 1991	18	48	60			
NAC3660FLSMP	1810	18	36	60			
NAC3060FLSMP	1628	18	30	60			
NAC2460FLSMP	1494	18	24	60			

- HPL Marker Board
- Aluminum frame with flat metal feet
- Clear rubber bumpers on feet
- Bulk pack pricing available – save money and reduce onsite packing materials by choosing this option. Contact our By Design Product Modifications Team for a price quote
- Frame Thickness 1½" x 1½"
- 60" High Frame has Foot Dimensions of 18" deep x 4" wide
- 72" High Frame has Foot Dimensions 19½" deep x 4" wide
- HPL Marker Board Screen
- Aluminum Painted Frame
- Feet ship in box with screen unattached
- Attach feet with screwdriver
- 2 people recommended for installation

### PET STATIC FLOOR SCREEN

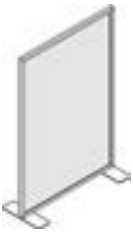

MODEL NO./DESCRIPTION	LIST PRICE	DIMENSIONS				CARTONED WEIGHT	CUBIC FEET
		D	W	H	A KW		
<b>1½" X 1½" FRAME THICKNESS 72" HIGH</b>							
NAC4872FLSPP	\$ 2739	18	48	72			
NAC3672FLSPP	2671	18	36	72			
NAC3072FLSPP	2633	18	30	72			
NAC2472FLSPP	1954	18	24	72			
<b>60" HIGH</b>							
NAC4860FLSPP	\$ 2659	18	48	60			
NAC3660FLSPP	2592	18	36	60			
NAC3060FLSPP	2562	18	30	60			
NAC2460FLSPP	1879	18	24	60			

- Nordic Knit PET
- Aluminum frame with flat metal feet
- Clear rubber bumpers on feet
- Frame Thickness 1½" x 1½"
- 60" High Frame has Foot Dimensions of 18" deep x 4" wide
- 72" High Frame has Foot Dimensions 19½" deep x 4" wide
- Nordic Knit PET Screen
- Aluminum Painted Frame
- Feet ship in box with screen unattached
- Attach feet with screwdriver
- 2 people recommended for installation

# STATIC FLOOR SCREEN - DESKS+BENCHING

**TO ORDER, SPECIFY:**

1. Model Number
2. Textile Grade / Color
3. Frame Paint Color

**SAMPLE MODEL NUMBER:**

NAC4872FLSPF

- See page 3 for Return To Work options

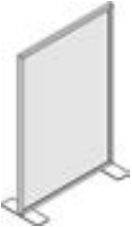
	MODEL NO./DESCRIPTION	LIST PRICE	DIMENSIONS	CARTONED CUBIC		
					D	W
<b>VERTICAL TEXTILE STATIC FLOOR SCREEN</b>  	<b>1½" X 1½" FRAME THICKNESS</b>	<b>GRADE A</b>	<b>GRADE B/ COM</b>			
	NAC4872FLSPF	\$ 1847	\$ 2032	18 48 72		
	NAC3672FLSPF	1696	1881	18 36 72		
	NAC3072FLSPF	1584	1769	18 30 72		
	NAC2472FLSPF	1552	1737	18 24 72		
	<b>60" HIGH</b>					
	NAC4860FLSPF	\$ 1756	\$ 1910	18 48 60		
	NAC3660FLSPF	1577	1731	18 36 60		
	NAC3060FLSPF	1509	1663	18 30 60		
	NAC2460FLSPF	1445	1599	18 24 60		

- Vertical Textile
- Aluminum frame with flat metal feet
- Clear rubber bumpers on feet
- Frame Thickness 1½" x 1½"
- 60" High Frame has Foot Dimensions of 18" deep x 4" wide
- 72" High Frame has Foot Dimensions 19½" deep x 4" wide
- Aluminum Painted Frame
- Feet ship in box with screen unattached
- Attach feet with screwdriver
- 2 people recommended for installation

## STATIC FLOOR SCREEN - DESKS+BENCHING

**TO ORDER, SPECIFY:**

1. Model Number
2. Paint Color

**SAMPLE MODEL NUMBER:**

NAC20FLSGBP

- See page 3 for Return To Work options

	MODEL NO./DESCRIPTION	LIST PRICE	DIMENSIONS				CARTONED CUBIC	
			D	W	H	A	KW	WEIGHT
<b>STATIC FLOOR SCREEN GANGING BRACKET</b> 	NAC20FLSGBP	\$ 193	6	19	1/8			
	<ul style="list-style-type: none"> <li>• To connect 2 static floor screens together in an L, or T configuration</li> <li>• Bracket Thickness 1/8"</li> <li>• Bracket is 6" deep x 19" wide</li> <li>• Steel</li> <li>• 2 people recommended for installation</li> </ul>							

# STATIC FLOOR SCREEN - DESKS+BENCHING

### TO ORDER, SPECIFY:

1. Model Number
2. Frame Paint Color

### SAMPLE MODEL NUMBERS:

NAC6072FLH30GP  
NAC6072FLH30BP

- See page 3 for Return To Work options

GLASS STATIC SURFACE/FLOOR SCREEN	MODEL NO./DESCRIPTION	LIST PRICE	DIMENSIONS			A	KW	CARTONED WEIGHT	CUBIC FEET
			D	W	H				
	<b>1½" X 1½" FRAME THICKNESS</b>								
	<b>72" HIGH</b>								
	NAC6072FLH30GP	\$ 2278	18	60	72				
	NAC4872FLH24GP	2052	18	48	72				
	<b>60" HIGH</b>								
	NAC6060FLH30GP	\$ 2103	18	60	60				
NAC4860FLH24GP	1904	18	48	60					
<ul style="list-style-type: none"> <li>• Clear Glass</li> <li>• Aluminum frame with flat metal feet</li> <li>• Clear rubber bumpers on feet</li> <li>• Specify 60" Wide models with 30" deep worksurfaces (30" will overhang worksurface)</li> <li>• Specify 48" Wide models with 24" deep worksurfaces (24" will overhang worksurface)</li> <li>• Bulk pack pricing available – save money and reduce onsite packing materials by choosing this option. Contact our By Design Product Modifications Team for a price quote</li> <li>• Frame Thickness 1½" x 1½"</li> <li>• 60" High Frame has Foot Dimensions of 18" deep x 4" wide</li> <li>• 72" High Frame has Foot Dimensions 19½" deep x 4" wide</li> <li>• Clear Tempered Glass Screen</li> <li>• Aluminum Painted Frame</li> <li>• Feet ship in box with screen unattached</li> <li>• Attach feet with screwdriver</li> <li>• 2 people recommended for installation</li> </ul>									

FLUTED POLYCARBONATE STATIC SURFACE/FLOOR SCREEN	MODEL NO./DESCRIPTION	LIST PRICE	DIMENSIONS			A	KW	CARTONED WEIGHT	CUBIC FEET
			D	W	H				
	<b>1½" X 1½" FRAME THICKNESS</b>								
	<b>72" HIGH</b>								
	NAC6072FLH30BP	\$ 2000	18	60	72				
	NAC4872FLH24BP	1610	18	48	72				
	<b>60" HIGH</b>								
	NAC6060FLH30BP	\$ 1719	18	60	60				
NAC4860FLH24BP	1508	18	48	60					
<ul style="list-style-type: none"> <li>• Semi-opaque fluted polycarbonate</li> <li>• Aluminum frame with flat metal feet</li> <li>• Clear rubber bumpers on feet</li> <li>• Specify 60" Wide models with 30" deep worksurfaces (30" will overhang worksurface)</li> <li>• Specify 48" Wide models with 24" deep worksurfaces (24" will overhang worksurface)</li> <li>• Bulk pack pricing available – save money and reduce onsite packing materials by choosing this option. Contact our By Design Product Modifications Team for a price quote</li> <li>• Frame Thickness 1½" x 1½"</li> <li>• 60" High Frame has Foot Dimensions of 18" deep x 4" wide</li> <li>• 72" High Frame has Foot Dimensions 19½" deep x 4" wide</li> <li>• Fluted, Semi-Opaque Polycarbonate Screen</li> <li>• Aluminum Painted Frame</li> <li>• Feet ship in box with screen unattached</li> <li>• Attach feet with screwdriver</li> <li>• 2 people recommended for installation</li> </ul>									

## STATIC FLOOR SCREEN - DESKS+BENCHING

### TO ORDER, SPECIFY:

1. Model Number
2. HPL Color
3. Frame Paint Color

### SAMPLE MODEL NUMBER:

NAC6072FLH30LP

- See page 3 for Return To Work options

MODEL NO./DESCRIPTION	LIST PRICE	DIMENSIONS				CARTONED WEIGHT	CUBIC FEET
		D	W	H	A		
<b>HPL STATIC SURFACE/FLOOR SCREEN</b>							
<b>1½" X 1½" FRAME THICKNESS 72" HIGH</b>							
NAC6072FLH30LP	\$ 2663	18	60	72			
NAC4872FLH24LP	2338	18	48	72			
<b>60" HIGH</b>							
NAC6060FLH30LP	\$ 2409	18	60	60			
NAC4860FLH24LP	2126	18	48	60			



- HPL
- Aluminum frame with flat metal feet
- Clear rubber bumpers on feet
- Specify 60" Wide models with 30" deep worksurfaces (30" will overhang worksurface)
- Specify 48" Wide models with 24" deep worksurfaces (24" will overhang worksurface)
- Bulk pack pricing available – save money and reduce onsite packing materials by choosing this option. Contact our By Design Product Modifications Team for a price quote
- Frame Thickness 1½" x 1½"
- 60" High Frame has Foot Dimensions of 18" deep x 4" wide
- 72" High Frame has Foot Dimensions 19½" deep x 4" wide
- HPL Screen
- Aluminum Painted Frame
- Feet ship in box with screen unattached
- Attach feet with screwdriver
- 2 people recommended for installation

# STATIC FLOOR SCREEN - DESKS+BENCHING

**TO ORDER, SPECIFY:**

1. Model Number
2. Frame Paint Color

**SAMPLE MODEL NUMBERS:**

NAC6072FLH30MP  
NAC6072FLH30PP

• See page 3 for Return To Work options

MODEL NO./DESCRIPTION	LIST PRICE	DIMENSIONS			A	KW	CARTONED WEIGHT	CUBIC FEET
		D	W	H				
<b>HPL MARKER BOARD STATIC SURFACE/FLOOR SCREEN</b>								
<b>1½" X 1½" FRAME THICKNESS 72" HIGH</b>								
NAC6072FLH30MP	\$ 2681	18	60	72				
NAC4872FLH24MP	2338	18	48	72				
<b>60" HIGH</b>								
NAC6060FLH30MP	\$ 2423	18	60	60				
NAC4860FLH24MP	2126	18	48	60				
<ul style="list-style-type: none"> <li>• HPL Marker Board</li> <li>• Aluminum frame with flat metal feet</li> <li>• Clear rubber bumpers on feet</li> <li>• Specify 60" Wide models with 30" deep worksurfaces (30" will overhang worksurface)</li> <li>• Specify 48" Wide models with 24" deep worksurfaces (24" will overhang worksurface)</li> <li>• Bulk pack pricing available – save money and reduce onsite packing materials by choosing this option. Contact our By Design Product Modifications Team for a price quote</li> <li>• Frame Thickness 1½" x 1½"</li> <li>• 60" High Frame has Foot Dimensions of 18" deep x 4" wide</li> <li>• 72" High Frame has Foot Dimensions 19½" deep x 4" wide</li> <li>• HPL Marker Board Screen</li> <li>• Aluminum Painted Frame</li> <li>• Feet ship in box with screen unattached</li> <li>• Attach feet with screwdriver</li> <li>• 2 people recommended for installation</li> </ul>								

**PET STATIC SURFACE/FLOOR  
SCREEN**



<b>1½" X 1½" FRAME THICKNESS 72" HIGH</b>								
NAC6072FLH30PP	\$ 3244	18	60	72				
NAC4872FLH24PP	3027	18	48	72				
<b>60" HIGH</b>								
NAC6060FLH30PP	\$ 3205	18	60	60				
NAC4860FLH24PP	2995	18	48	60				
<ul style="list-style-type: none"> <li>• PET</li> <li>• Aluminum frame with flat metal feet</li> <li>• Clear rubber bumpers on feet</li> <li>• Specify 60" Wide models with 30" deep worksurfaces (30" will overhang worksurface)</li> <li>• Specify 48" Wide models with 24" deep worksurfaces (24" will overhang worksurface)</li> <li>• Frame Thickness 1½" x 1½"</li> <li>• 60" High Frame has Foot Dimensions of 18" deep x 4" wide</li> <li>• 72" High Frame has Foot Dimensions 19½" deep x 4" wide</li> <li>• Nordic Knit PET Screen</li> <li>• Aluminum Painted Frame</li> <li>• Feet ship in box with screen unattached</li> <li>• Attach feet with screwdriver</li> <li>• 2 people recommended for installation</li> </ul>								

## STATIC FLOOR SCREEN - DESKS+BENCHING

### TO ORDER, SPECIFY:

1. Model Number
2. Textile Grade / Color
3. Frame Paint Color

### SAMPLE MODEL NUMBER:

NAC6072FLH30PF

- See page 3 for Return To Work options



	MODEL NO./DESCRIPTION	LIST PRICE	DIMENSIONS			CARTONED WEIGHT	CUBIC FEET
			D	W	H		
<b>VERTICAL TEXTILE STATIC SURFACE/FLOOR SCREEN</b>	<b>1½" X 1½" FRAME THICKNESS 72" HIGH</b>	<b>GRADE A</b>	<b>GRADE B/ COM</b>				
	NAC6072FLH30PF	\$ 2327	\$ 2512	18	60	72	
	NAC4872FLH24PF	1992	2177	18	48	72	
	<b>60" HIGH</b>						
	NAC6060FLH30PF	\$ 2232	\$ 2386	18	60	60	
	NAC4860FLH24PF	1917	2071	18	48	60	

- Vertical Textile
- Aluminum frame with flat metal feet
- Clear rubber bumpers on feet
- Specify 60" Wide models with 30" deep worksurfaces (30" will overhang worksurface)
- Specify 48" Wide models with 24" deep worksurfaces (24" will overhang worksurface)
- Frame Thickness 1½" x 1½"
- 60" High Frame has Foot Dimensions of 18" deep x 4" wide
- 72" High Frame has Foot Dimensions 19½" deep x 4" wide
- Aluminum Painted Frame
- Feet ship in box with screen unattached
- Attach feet with screwdriver
- 2 people recommended for installation

# MOBILE FLOOR SCREEN - DESKS+BENCHING

**TO ORDER, SPECIFY:**

1. Model Number
2. Frame Paint Color

**SAMPLE MODEL NUMBERS:**

NAC4872FLMGP  
NAC4872FLMBP

• See page 3 for Return To Work options

**GLASS MOBILE FLOOR SCREEN**



**MODEL NO./DESCRIPTION**

**1½" X 1½" FRAME THICKNESS  
74% HIGH**

MODEL NO./DESCRIPTION	LIST PRICE	D	W	H	A	KW	CARTONED WEIGHT	CUBIC FEET
NAC4872FLMGP	\$ 2209	18	48	74%				
NAC3672FLMGP	1957	18	36	74%				
NAC3072FLMGP	1703	18	30	74%				
NAC2472FLMGP	1591	18	24	74%				

**62% HIGH**

NAC4860FLMGP	\$ 1990	18	48	62%				
NAC3660FLMGP	1794	18	36	62%				
NAC3060FLMGP	1597	18	30	62%				
NAC2460FLMGP	1504	18	24	62%				

- Clear Glass
- Aluminum frame with flat metal feet with locking 1½" diameter caster
- Bulk pack pricing available – save money and reduce onsite packing materials by choosing this option. Contact our By Design Product Modifications Team for a price quote
- Frame Thickness 1½" x 1½"
- 60" high Frame is 62% high with casters (Foot Dimension 18" deep x 4" wide)
- 72" high Frame is 74% high with casters (Foot Dimension 19½" deep x 4" wide)
- Clear Tempered Glass Screen
- Aluminum Painted Frame
- Feet ship in box with screen unattached
- Attach feet with screwdriver
- 2 people recommended for installation

**FLUTED POLYCARBONATE MOBILE FLOOR SCREEN**



**1½" X 1½" FRAME THICKNESS  
74% HIGH**

NAC4872FLMBP	\$ 1912	18	48	74%				
NAC3672FLMBP	1727	18	36	74%				
NAC3072FLMBP	1542	18	30	74%				
NAC2472FLMBP	1430	18	24	74%				

**62% HIGH**

NAC4860FLMBP	\$ 1738	18	48	62%				
NAC3660FLMBP	1596	18	36	62%				
NAC3060FLMBP	1453	18	30	62%				
NAC2460FLMBP	1357	18	24	62%				

- Semi-opaque fluted polycarbonate
- Aluminum frame with flat metal feet with locking 1½" diameter caster
- Bulk pack pricing available – save money and reduce onsite packing materials by choosing this option. Contact our By Design Product Modifications Team for a price quote
- Frame Thickness 1½" x 1½"
- 60" high Frame is 62% high with casters (Foot Dimension 18" deep x 4" wide)
- 72" high Frame is 74% high with casters (Foot Dimension 19½" deep x 4" wide)
- Fluted, Semi-Opaque Polycarbonate Screen
- Aluminum Painted Frame
- Feet ship in box with screen unattached
- Attach feet with screwdriver
- 2 people recommended for installation



## MOBILE FLOOR SCREEN - DESKS+BENCHING

### TO ORDER, SPECIFY:

1. Model Number
2. HPL Color
3. Frame Paint Color

### SAMPLE MODEL NUMBER:

NAC4872FLMLP

- See page 3 for Return To Work options

MODEL NO./DESCRIPTION	LIST PRICE	DIMENSIONS				CARTONED CUBIC WEIGHT	CUBIC FEET
		D	W	H	A		
<b>HPL MOBILE FLOOR SCREEN</b>							
<b>1½" X 1½" FRAME THICKNESS</b>							
<b>74¾" HIGH</b>							
NAC4872FLMLP	\$ 2335	18	48	74¾"			
NAC3672FLMLP	2126	18	36	74¾"			
NAC3072FLMLP	1915	18	30	74¾"			
NAC2472FLMLP	1752	18	24	74¾"			
<b>62¾" HIGH</b>							
NAC4860FLMLP	\$ 2123	18	48	62¾"			
NAC3660FLMLP	1942	18	36	62¾"			
NAC3060FLMLP	1761	18	30	62¾"			
NAC2460FLMLP	1626	18	24	62¾"			



- HPL
- Aluminum frame with flat metal feet with locking 1¾" diameter caster
- Bulk pack pricing available – save money and reduce onsite packing materials by choosing this option. Contact our By Design Product Modifications Team for a price quote
- Frame Thickness 1½" x 1½"
- 60" high Frame is 62¾" high with casters (Foot Dimension 18" deep x 4" wide)
- 72" high Frame is 74¾" high with casters (Foot Dimension 19½" deep x 4" wide)
- HPL Screen
- Aluminum Painted Frame
- Feet ship in box with screen unattached
- Attach feet with screwdriver
- 2 people recommended for installation

# MOBILE FLOOR SCREEN - DESKS+BENCHING

**TO ORDER, SPECIFY:**

1. Model Number
2. Frame Paint Color

**SAMPLE MODEL NUMBERS:**

NAC4872FLMMP  
NAC4872FLMPP

• See page 3 for Return To Work options

**HPL MARKER BOARD  
MOBILE FLOOR SCREEN**



**MODEL NO./DESCRIPTION**

**1½" X 1½" FRAME THICKNESS  
74¾" HIGH**

MODEL NO./DESCRIPTION	LIST PRICE	DIMENSIONS			CARTONED WEIGHT	CUBIC FEET
		D	W	H		
NAC4872FLMMP	\$ 2335	18	48	74¾"		
NAC3672FLMMP	2126	18	36	74¾"		
NAC3072FLMMP	1915	18	30	74¾"		
NAC2472FLMMP	1752	18	24	74¾"		

**62¾" HIGH**

NAC4860FLMMP	\$ 2123	18	48	62¾"		
NAC3660FLMMP	1942	18	36	62¾"		
NAC3060FLMMP	1761	18	30	62¾"		
NAC2460FLMMP	1626	18	24	62¾"		

- HPL Marker Board
- Aluminum frame with flat metal feet with locking 1¼" diameter caster
- Bulk pack pricing available – save money and reduce onsite packing materials by choosing this option. Contact our By Design Product Modifications Team for a price quote
- Frame Thickness 1½" x 1½"
- 60" high Frame is 62¾" high with casters (Foot Dimension 18" deep x 4" wide)
- 72" high Frame is 74¾" high with casters (Foot Dimension 19½" deep x 4" wide)
- HPL Marker Board Screen
- Aluminum Painted Frame
- Feet ship in box with screen unattached
- Attach feet with screwdriver
- 2 people recommended for installation

**PET MOBILE FLOOR SCREEN**

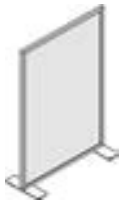

**1½" X 1½" FRAME THICKNESS  
72" HIGH**

NAC4872FLMPP	\$ 2877	18	48	72"		
NAC3672FLMPP	2808	18	36	72"		
NAC3072FLMPP	2772	18	30	72"		
NAC2472FLMPP	2091	18	24	72"		

**60" HIGH**

NAC4860FLMPP	\$ 2797	18	48	60"		
NAC3660FLMPP	2730	18	36	60"		
NAC3060FLMPP	2701	18	30	60"		
NAC2460FLMPP	2016	18	24	60"		

- Nordic Knit PET
- Aluminum frame with flat metal feet with locking 1¼" diameter caster
- Frame Thickness 1½" x 1½"
- 60" high Frame has 18" deep x 4" wide feet with casters
- 72" high Frame has 19½" deep x 4" wide feet with casters
- Nordic Knit PET Screen
- Aluminum Painted Frame
- Feet ship in box with screen unattached
- Attach feet with screwdriver
- 2 people recommended for installation

## MOBILE FLOOR SCREEN - DESKS+BENCHING

### TO ORDER, SPECIFY:

1. Model Number
2. Textile Grade / Color
3. Frame Paint Color

### SAMPLE MODEL NUMBER:

NAC4872FLMPF

- See page 3 for Return To Work options

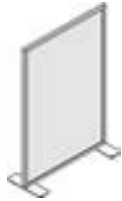

MODEL NO./DESCRIPTION	LIST PRICE	DIMENSIONS				CARTONED WEIGHT	CUBIC FEET
		D	W	H	A		
<b>VERTICAL TEXTILE MOBILE FLOOR SCREEN</b>							
<b>1½" X 1½" FRAME THICKNESS</b>							
<b>72" HIGH</b>							
NAC4872FLMPF	\$ 1984	\$ 2169	18	48	72		
NAC3672FLMPF	1835	2020	18	36	72		
NAC3072FLMPF	1722	1907	18	30	72		
NAC2472FLMPF	1692	1877	18	24	72		
<b>60" HIGH</b>							
NAC4860FLMPF	\$ 1894	\$ 2048	18	48	60		
NAC3660FLMPF	1717	1871	18	36	60		
NAC3060FLMPF	1647	1801	18	30	60		
NAC2460FLMPF	1585	1739	18	24	60		

- Vertical Textile
- Aluminum frame with flat metal feet with locking 1½" diameter caster
- Frame Thickness 1½" x 1½"
- 60" high Frame has 18" deep x 4" wide feet with casters
- 72" high Frame has 19½" deep x 4" wide feet with casters
- Aluminum Painted Frame
- Feet ship in box with screen unattached
- Attach feet with screwdriver
- 2 people recommended for installation

# UNIVERSAL PANEL MOUNT PRIVACY SCREEN - DESKS+BENCHING

**TO ORDER, SPECIFY:**

1. Model Number
2. Resin Color

**SAMPLE MODEL NUMBER:**

NAC4818PVUPR

- See page 3 for Return To Work options

	MODEL NO./DESCRIPTION	LIST PRICE	DIMENSIONS					CARTONED CUBIC	
			D	W	H	A	KW	WEIGHT	FEET
<b>BASIC SCREEN WITH UNIVERSAL BRACKET - RESIN: FOR 3/4"; 1 1/2" - 2 1/2" THICK PANELS</b>	<b>1/4" RESIN THICKNESS</b>								
	<b>18" HIGH</b>								
	NAC4818PVUPR	\$ 640	48	18					
	NAC4218PVUPR	631	42	18					
	NAC3618PVUPR	526	36	18					
	NAC3018PVUPR	496	30	18					
	NAC2418PVUPR	428	24	18					



- Universal bracket is silver
- Resin available in Clear or Frosted with radiused corners
- Fits on 3/4"; 1 1/2" - 2 1/2" panel thicknesses. Use included spacers for secure fit. Spacers not recommended for field cut
- Bulk pack pricing available – save money and reduce onsite packing materials by choosing this option. Contact our By Design Product Modifications Team for a price quote
- Resin Thickness 1/4"
- Clear or Frosted Resin Screen
- Metal Mounting Bracket
- Brackets ship in box with screen
- Remove protective film from screen
- Will require attachment to panel with fasteners – 2 people recommended for installation

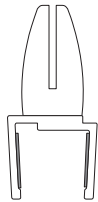

Use one 1/8" foam pad per side for 1 1/2" to 2 1/2" thick panels

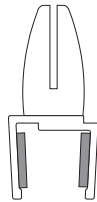

Use one 1/4" foam pad per side for 1" to 1 1/2" thick panels

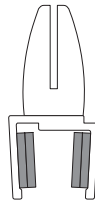

Use two 1/4" foam pads per side for 3/4" to 1" thick panels

## UNIVERSAL PANEL MOUNT PRIVACY SCREEN - DESKS+C2NG

**TO ORDER, SPECIFY:**

1. Model Number
2. Resin Color

**SAMPLE MODEL NUMBER:**

NAC4818PVUP3R

- See page 3 for Return To Work options

	MODEL NO./DESCRIPTION	LIST PRICE	DIMENSIONS					CARTONED CUBIC	
			D	W	H	A	KW	WEIGHT	FEET
<b>BASIC SCREEN WITH UNIVERSAL BRACKET - RESIN: FOR 2½" - 3½" THICK PANELS</b>	<b>⅜" RESIN THICKNESS 18" HIGH</b>								
	NAC4818PVUP3R	\$ 791		48	18				
	NAC4218PVUP3R	773		42	18				
	NAC3618PVUP3R	626		36	18				
	NAC3018PVUP3R	563		30	18				
	NAC2418PVUP3R	463		24	18				



- Universal bracket is silver
- Resin available in Clear or Frosted with radiused corners
- Fits on 2½" – 3½" panel thicknesses. Use included spacers for secure fit
- Resin Thickness ⅜"
- Clear or Frosted Resin Screen
- Metal Mounting Bracket
- Brackets ship in box with screen
- Remove protective film from screen
- Will require attachment to panel with fasteners – 2 people recommended for installation

# UNIVERSAL PANEL MOUNT PRIVACY SCREEN - DESKS+BENCHING

## TO ORDER, SPECIFY:

1. Model Number

## SAMPLE MODEL NUMBER:

NAC4818PVUPG

• See page 3 for Return To Work options

	MODEL NO./DESCRIPTION	LIST PRICE	DIMENSIONS					CARTONED CUBIC	
			D	W	H	A	KW	WEIGHT	FEET
<b>BASIC SCREEN WITH UNIVERSAL BRACKET - GLASS: FOR 3/4"; 1 1/2" - 2 1/2" THICK PANELS</b>	<b>1/4" GLASS THICKNESS 18" HIGH</b>								
	NAC4818PVUPG	\$ 537		48	18				
	NAC4218PVUPG	498		42	18				
	NAC3618PVUPG	459		36	18				
	NAC3018PVUPG	420		30	18				
	NAC2418PVUPG	381		24	18				



- Universal bracket is silver
- Fits on 3/4"; 1 1/2" - 2 1/2" panel thicknesses. Use included spacers for secure fit. Spacers not recommended for field cut
- Bulk pack pricing available – save money and reduce onsite packing materials by choosing this option. Contact our By Design Product Modifications Team for a price quote
- Glass Thickness 1/4"
- Clear Glass Screen
- Metal Mounting Bracket
- Brackets ship in box with screen
- Remove protective film from screen
- Will require attachment to panel with fasteners – 2 people recommended for installation

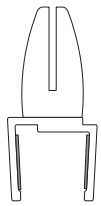

Use one 3/8" foam pad per side for 1 1/2" to 2 1/2" thick panels

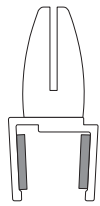

Use one 1/4" foam pad per side for 1" to 1 1/2" thick panels

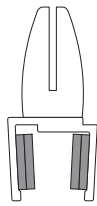

Use two 1/4" foam pads per side for 3/4" to 1" thick panels

## UNIVERSAL PANEL MOUNT PRIVACY SCREEN - DESKS+C2NG

**TO ORDER, SPECIFY:**

1. Model Number
2. Glass

**SAMPLE MODEL NUMBER:**

NAC4818PVUP3G

- See page 3 for Return To Work options

	MODEL NO./DESCRIPTION	LIST PRICE	DIMENSIONS					CARTONED WEIGHT	CUBIC FEET
			D	W	H	A	KW		
<b>BASIC SCREEN WITH UNIVERSAL BRACKET - GLASS: FOR 2½" - 3½" THICK PANELS</b>	<b>¼" GLASS THICKNESS</b>								
	<b>18" HIGH</b>								
	NAC4818PVUP3G	\$ 573		48	18				
	NAC4218PVUP3G	534		42	18				
	NAC3618PVUP3G	488		36	18				
	NAC3018PVUP3G	444		30	18				
	NAC2418PVUP3G	405		24	18				



- Universal bracket is silver
- Fits on 2½" – 3½" panel thicknesses. Use included spacers for secure fit
- Glass Thickness ¼"
- Clear Glass Screen
- Metal Mounting Bracket
- Brackets ship in box with screen
- Remove protective film from screen
- Will require attachment to panel with fasteners – 2 people recommended for installation

# WALL EQUIPMENT RAIL - ACCESSORIES

**TO ORDER, SPECIFY:**

1. Model Number

**SAMPLE MODEL NUMBER:**

NAC48ER

• See page 3 for Return To Work options

	MODEL NO./DESCRIPTION	LIST PRICE	DIMENSIONS			CARTONED CUBIC		
			D	W	H	A	KW	WEIGHT
	NAC48ER	\$ 583	1	48¼	1			
	NAC42ER	562	1	42¼	1			
	NAC36ER	486	1	36¼	1			
	NAC30ER	469	1	30¼	1			
	NAC24ER	389	1	24¼	1			
	NAC18ER	372	1	18¼	1			

- Attaches to architectural wall to hold accessories
- 18" - 48" rail lengths available
- Extruded Aluminum rail with Silver inlay
- Predrilled mounting holes
- Two friction-fit injection molded thermoplastic end caps
- Will require attachment to wall with fasteners - 2 people recommended for installation



## ADD-ONS FOR WALL EQUIPMENT RAIL - ACCESSORIES

**TO ORDER, SPECIFY:**

1. Model Number

**SAMPLE MODEL NUMBER:**

NAC1ERKWSD

• See page 3 for Return To Work options

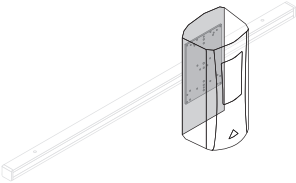
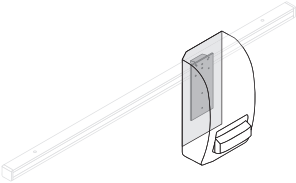
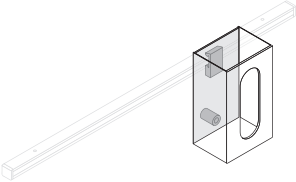
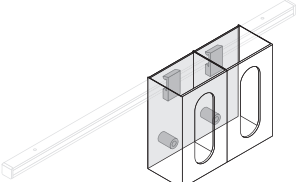
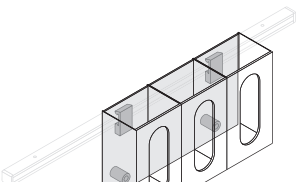
	MODEL NO./DESCRIPTION	LIST PRICE	DIMENSIONS				CARTONED WEIGHT	CUBIC FEET
			D	W	H	A KW		
<b>MOUNTING KIT FOR WIDE-BODY SOAP/SANITIZER DISPENSER</b> 	NAC1ERKWSD	\$ 575	¾	5	7			
	<ul style="list-style-type: none"> <li>• Designed to hold most wide-body soap or sanitizer dispenser</li> <li>• Dispenser is not included</li> </ul>							
<b>MOUNTING KIT FOR NARROW-BODY SOAP/SANITIZER DISPENSER</b> 	NAC1ERKNSD	\$ 525	¾	5	4¼			
	<ul style="list-style-type: none"> <li>• Designed to hold most narrow-body soap or sanitizer dispenser</li> <li>• Dispenser is not included</li> </ul>							
<b>SINGLE UNIVERSAL GLOVE BOX HOLDER</b> 	NAC1ERGV1	\$ 876	5	5¾	10			
	<ul style="list-style-type: none"> <li>• Holds one glove box</li> <li>• Clear acrylic</li> </ul>							
<b>DOUBLE UNIVERSAL GLOVE BOX HOLDER</b> 	NAC1ERGV2	\$ 990	5	16¾	10			
	<ul style="list-style-type: none"> <li>• Holds two glove boxes</li> <li>• Clear acrylic</li> </ul>							
<b>TRIPLE UNIVERSAL GLOVE BOX HOLDER</b> 	NAC1ERGV3	\$ 1141	5	11¾	10			
	<ul style="list-style-type: none"> <li>• Holds three glove boxes</li> <li>• Clear acrylic</li> </ul>							

## ADD-ONS FOR WALL EQUIPMENT RAIL - ACCESSORIES

### TO ORDER, SPECIFY:

1. Model Number

### SAMPLE MODEL NUMBER:

NAC14ERKPPD

• See page 3 for Return To Work options

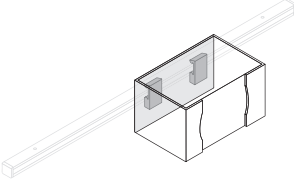
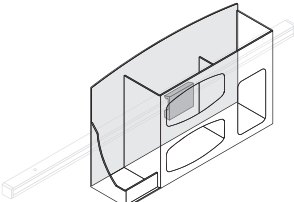
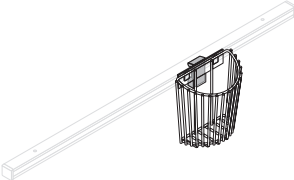
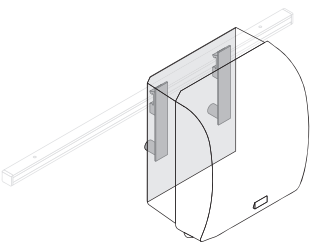
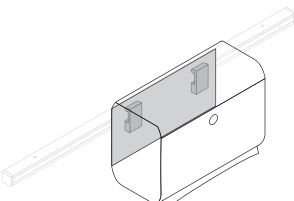
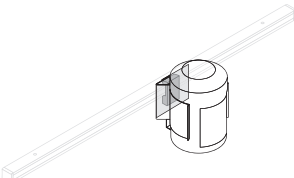
	MODEL NO./DESCRIPTION	LIST PRICE	DIMENSIONS			CARTONED CUBIC		
			D	W	H	A	KW	WEIGHT
<b>SMALL PPE DISPENSER</b> 	NAC14ERKPPD	\$ 977	7	13¾	5¾			
	<ul style="list-style-type: none"> <li>• Universal small box dispenser for shoe cover, cap and other items</li> <li>• Horizontal top feed or vertical side feed application</li> </ul>							
<b>PPE DISPENSER CABINET</b> 	NAC19ERKPPDC	\$ 1158	4½	18½	11½			
	<ul style="list-style-type: none"> <li>• Holds 2 boxes of gloves, 1 box of face masks and 1 hand sanitizer bottle</li> <li>• Horizontal top feed application</li> </ul>							
<b>U-SHAPED WIRE BASKET</b> 	NAC07ERKUWB	\$ 682	4	6¾	7			
	<ul style="list-style-type: none"> <li>• Plastic coated wire</li> <li>• Holds blood pressure cuff and other accessories</li> </ul>							
<b>MOUNTING KIT FOR PAPER TOWEL DISPENSER</b> 	NAC1ERKSPTD	\$ 675	¾	5	7			
	<ul style="list-style-type: none"> <li>• Designed to hold most paper towel dispensers</li> <li>• Includes stand-off bracket</li> <li>• Dispenser is not included</li> </ul>							
<b>MOUNTING KIT FOR TRI-FOLD PAPER TOWEL DISPENSER</b> 	NAC1ERKTPTD	\$ 525	¾	6	2¾			
	<ul style="list-style-type: none"> <li>• Designed to hold most tri-fold dispensers</li> <li>• Dispenser is not included</li> </ul>							
<b>WIPE HOLDER</b> 	NAC1ERKWPH	\$ 770	5	5	6			
	<ul style="list-style-type: none"> <li>• For most brands of sanitizing wipes</li> <li>• Also fits some industrial style spray bottles</li> </ul>							

## ALLOY MID-SUPPORT PANELS - DESKS+BENCHING

**TO ORDER, SPECIFY:**

1. Model Number

**SAMPLE MODEL NUMBER:**

71N6046SMSAL

• See page 3 for Return To Work options

ALLOY MID-SUPPORT PANEL	MODEL NO./DESCRIPTION	LIST PRICE	DIMENSIONS					CARTONED WEIGHT	CUBIC FEET
			D	W	H	A	KW		
	71N6046SMSAL	\$ 875	60	46					
	71N4846SMSAL	838	48	46					
	71N2946SMSAL	533	29	46					
	71N2346SMSAL	495	23	46					
	71N3246SMSAL	533	32	46					
	71N2646SMSAL	495	26	46					
	71N6046SMSFL	646	60	46					
	71N4846SMSFL	609	48	46					
	71N3246SMSFL	304	32	46					
	71N3046SMSFL	304	30	46					
	71N2646SMSFL	267	26	46					
	71N2446SMSFL	267	24	46					
	71NGBDMA21	72							
	71NGBDMA22	72							
	71NGBDMA23	72							
	71NGBSMA21	343							
	71NGBSMA22	343							
	71NGBSMA23	343							
	71NGBSMF21	113							
	71NGBSMF22	113							
	71NGBSMF23	113							
	71N24ELJ	86							
	71N24ELJ8	140							

- Similar to existing Alloy end panels, these new mid-support panels create separation between users, side to side
- Intended for new product installations, as well as retrofitting of existing installations
- Accommodates double sided and single sided models
- Can be used with height adjustable and freestanding models, does not apply to starter, mid, and ender models
- New jumper size added to support use with mid-support panels
- New ganging | cover brackets offered in silver, black, and white
- 48" - 60" Wide x 46" High Double Sided
- 24" - 30" Wide x 46" High Single Sided
- HPL Laminate
- Medium level of complexity - these would require a 2 person installation

## REVISION SUMMARY

---

### EFFECTIVE 03.13.23

---

#### **SURFACE MATERIALS**

Changes made to Surface Materials sections due to Harmonization of Laminate, Wood and Vertical Textiles where applicable

Seating textiles Echo, Orbit, Connect Four colorways Clementine and Coffee Bean, Input colorways Pine, Mint, and Flame, Strand colorway Fudge have been discontinued

### EFFECTIVE 09.19.22

---

#### **GLOBAL**

Pricing has been updated to reflect March 2022 Commercial Pricing