

| | |
|--------------------------|----------|
| Price List Dates: | |
| Pricing | 10.02.23 |
| Revisions | 08.28.23 |



▶ See page

| | |
|------------------------------|------|
| Statement of Line | BO.2 |
| Planning | BO.3 |
| Overview | BO.3 |
| Leg Options | BO.4 |
| Pricing | BO.5 |
| One-Seat Lounges | BO.5 |
| Two-Seat Lounges | BO.6 |
| Three-Seat Lounges | BO.7 |
| Surface Materials | BO.8 |
| Upholstery | BO.8 |
| COM/COL Yardage Requirements | BO.9 |

Kimball®

BOYD® SEATING

Lounge

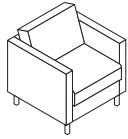

One-Seat Lounge

▶ See page BO.5 to specify.

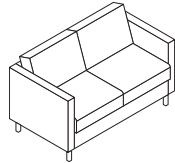

Two-Seat Lounge

▶ See page BO.5 to specify.

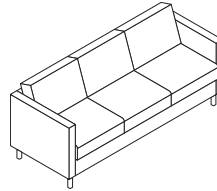

Three-Seat Lounge

▶ See page BO.5 to specify.

Statement of Line

| | |
|-------------------|-----------------|
| Statement of Line | ▶ See page BO.2 |
| Planning | BO.3 |
| Pricing | BO.5 |
| Surface Materials | BO.8 |

▶ See individual pricing pages for dimensions.

BOYD® SEATING

Overview

Planning

| | |
|-------------------|-----------------|
| Statement of Line | ▶ See page BO.2 |
| Planning | BO.3 |
| Pricing | BO.5 |
| Surface Materials | BO.8 |

Back cushion contains 4³/₄"-thick high-density, high-resiliency, CFC-free, laminated polyurethane foam. Select standard cushion or sewn-tufted cushion.

Frame is constructed of plywood, utilizing lap joint construction that is glued and screwed.

6"H legs are powder-coated steel and available in three styles: square, round or Y.

▶ See page BO.4.

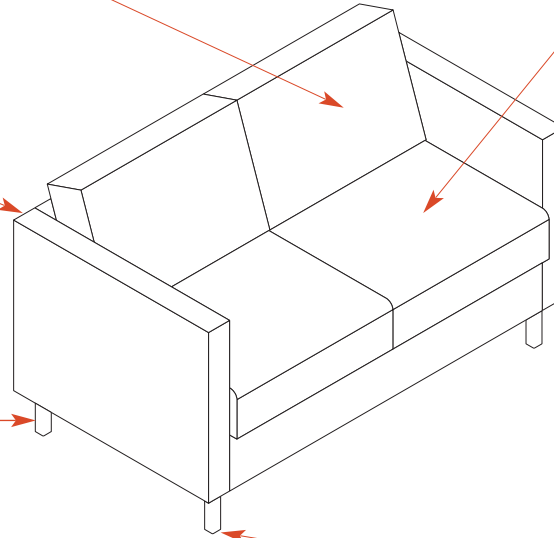

Attached seat cushion is 6"-thick thick and made of high-grade, high-resiliency, CFC-free, laminated polyurethane.

Non-skid, adjustable glides are 2" in diameter.

Boyd is offered in one-, two-, and three-seat lounge models. Models meet or exceed the applicable BIFMA/ANSI standards.

Leg and rail joints are double doweled, securely glued, and reinforced with corner blocks that are then glued and screwed to the base rails. The base frame is attached to the seat frame with wood screws through the rails.

Back cushions consist of high-density, high-resiliency foam over a non-stretch woven suspension that is stapled to the frame.

Seat is designed for comfort, giving you a residential feel. Wrinkles in the seat cushion are adherent to the design and should be expected.

Arms feature a sewn slipcover over top 1/2"-thick, high-grade polyurethane foam.

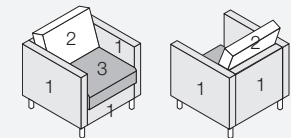

Contrasting textiles or leather may be specified on the outer frame (1), back cushion (2), and seat cushion (3).

Accent pillows are available.
▶ See the Accent Pillow chapter in the *Kimball Seating Price List*.

BOYD® SEATING

Leg Options

Planning

| | |
|-------------------|-----------------|
| Statement of Line | ▶ See page BO.2 |
| Planning | BO.3 |
| Pricing | BO.5 |
| Surface Materials | BO.8 |

Square Metal Leg:

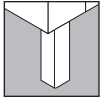

S

Finishes:

- 405** Designer White
- 462** Cinder
- 501** Platinum Metallic

Round Metal Leg:

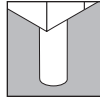

R

Finishes:

- 405** Designer White
- 462** Cinder
- 501** Platinum Metallic

Y Metal Leg:

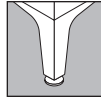

Y

Finishes:

- 462** Cinder
- 497** Polished Aluminum
- 501** Platinum Metallic

How to Specify

Specify leg option and finish together in one step.

Example:

S405 = Square metal leg in Designer White

BOYD® SEATING

One-Seat Lounges

Pricing

| | |
|-------------------|-----------------|
| Statement of Line | ▶ See page BO.2 |
| Planning | BO.3 |
| Pricing | BO.5 |
| Surface Materials | BO.8 |

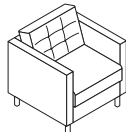

Sewn-Tufted Back Cushion

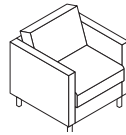

Standard Back Cushion

| Model | Description | Kimball International Seating Textile/Leather Price Grade | | | | | | | | | Shipping | | GSA |
|--------|--------------------------|---|-------|-------|------|------|------|------|------|------|----------|------------|-------|
| | | 1 | 2/COM | 3/COL | 4 | 5 | 6 | 7 | L7 | L8 | lbs. | Cubic Feet | SIN |
| K741AT | Sewn-tufted back cushion | \$2654 | 2950 | 3110 | 3304 | 3583 | 3857 | 4130 | 5282 | 5933 | 94.00 | 22.30 | 33721 |
| K741A | Standard back cushion | \$2309 | 2605 | 2765 | 2959 | 3238 | 3512 | 3785 | 4937 | 5588 | 94.00 | 22.30 | 33721 |

| Model | Alliance Program Seating Textile Price Grade | | | | | | | | | | | | | | | | | |
|--------|--|------|------|------|------|------|------|------|------|------|------|------|------|------|------|------|------|------|
| | A | B | C | D | E | F | G | H | I | J | K | L | M | N | O | P | Q | R |
| K741AT | \$3083 | 3287 | 3446 | 3612 | 3788 | 3995 | 4109 | 4337 | 4524 | 4717 | 5025 | 5641 | 6034 | 6125 | 6199 | 6296 | 6389 | 6821 |
| K741A | \$2738 | 2942 | 3101 | 3267 | 3443 | 3650 | 3764 | 3992 | 4179 | 4372 | 4680 | 5296 | 5689 | 5780 | 5854 | 5951 | 6044 | 6476 |

| Description | Dimensions (Inches) | | | | | | |
|-----------------------|---------------------|-----|----|------|-----|----|-----|
| | Overall | | | Seat | | | Arm |
| | H | W | D | H | W | D | H |
| Sewn-tufted cushion | 32 | 28½ | 30 | 19 | 22½ | 19 | 26½ |
| Standard back cushion | 32 | 28½ | 30 | 19 | 22½ | 19 | 26½ |

Tips

IMPORTANT: Orders cannot be cancelled for chairs specified with Alliance Program textiles.

When specifying a striped or directional textile, a solid pattern is recommended for the back cushion due to alignment constraints.

Contrasting textiles or leather are available. Use an electronic specification tool for accurate pricing.

Models that meet TB133 requirements are available in select textiles or leather.

▶ Contact **By Design**.

How to Specify

- ① Model
 - Frame (primary):
 - ② Textile or leather grade or Alliance prefix + grade
 - ③ Textile or leather number
- Back Cushion:
 - ④ Textile or leather grade or Alliance prefix + grade
 - ⑤ Textile or leather number
- Seat Cushion:
 - ⑥ Textile or leather grade or Alliance prefix + grade
 - ⑦ Textile or leather number
- ⑧ Leg option:
 - ▶ See page BO.4 for designators.

BOYD® SEATING

Two-Seat Lounges

Pricing

| | |
|-------------------|-----------------|
| Statement of Line | ▶ See page BO.2 |
| Planning | BO.3 |
| Pricing | BO.5 |
| Surface Materials | BO.8 |

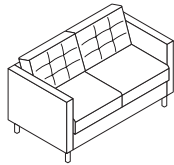

Sewn-Tufted Back Cushion

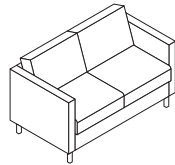

Standard Back Cushion

| Model | Description | Kimball International Seating Textile/Leather Price Grade | | | | | | | | | | Shipping | | GSA |
|---------------|--------------------------|---|-------|-------|------|------|------|------|------|------|--------|------------|-------|-----|
| | | 1 | 2/COM | 3/COL | 4 | 5 | 6 | 7 | L7 | L8 | lbs. | Cubic Feet | SIN | |
| K742AT | Sewn-tufted back cushion | \$3945 | 4309 | 4505 | 4743 | 5087 | 5423 | 5759 | 7173 | 7971 | 145.00 | 37.90 | 33721 | |
| K742A | Standard back cushion | \$3256 | 3620 | 3816 | 4054 | 4398 | 4734 | 5070 | 6484 | 7282 | 145.00 | 37.90 | 33721 | |

| Model | Alliance Program Seating Textile Price Grade | | | | | | | | | | | | | | | | | |
|---------------|--|------|------|------|------|------|------|------|------|------|------|------|------|------|------|------|------|------|
| | A | B | C | D | E | F | G | H | I | J | K | L | M | N | O | P | Q | R |
| K742AT | \$4471 | 4723 | 4919 | 5121 | 5339 | 5591 | 5731 | 6011 | 6241 | 6479 | 6857 | 7613 | 6034 | 8209 | 8299 | 8419 | 8531 | 9063 |
| K742A | \$3782 | 4034 | 4230 | 4432 | 4650 | 4902 | 5042 | 5322 | 5552 | 5790 | 6168 | 6924 | 7408 | 7520 | 7610 | 7730 | 7842 | 8374 |

| Description | Dimensions (Inches) | | | | | | |
|-----------------------|---------------------|----|----|------|----|-----|-----|
| | Overall | | | Seat | | Arm | |
| | H | W | D | H | W | D | H |
| Sewn-tufted cushion | 32 | 51 | 30 | 19 | 45 | 19 | 26½ |
| Standard back cushion | 32 | 51 | 30 | 19 | 45 | 19 | 26½ |

Tips

IMPORTANT: Orders cannot be cancelled for chairs specified with Alliance Program textiles.

When specifying a striped or directional textile, a solid pattern is recommended for the back cushion due to alignment constraints.

Contrasting textiles or leather are available. Use an electronic specification tool for accurate pricing.

Models that meet TB133 requirements are available in select textiles or leather.

▶ Contact **By Design**.

How to Specify

- ① Model
 - Frame (primary):
 - ② Textile or leather grade or Alliance prefix + grade
 - ③ Textile or leather number
 - Back Cushion:
 - ④ Textile or leather grade or Alliance prefix + grade
 - ⑤ Textile or leather number
 - Seat Cushion:
 - ⑥ Textile or leather grade or Alliance prefix + grade
 - ⑦ Textile or leather number
 - ⑧ Leg option:
 - ▶ See page BO.4 for designators.

BOYD® SEATING

Three-Seat Lounges

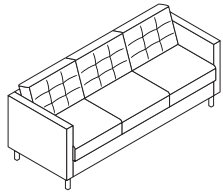

Sewn-Tufted Back Cushion

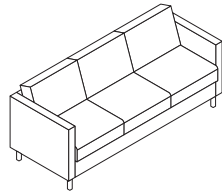

Standard Back Cushion

Pricing

| | |
|-------------------|-----------------|
| Statement of Line | ▶ See page BO.2 |
| Planning | BO.3 |
| Pricing | BO.5 |
| Surface Materials | BO.8 |

Tips

IMPORTANT: Orders cannot be cancelled for chairs specified with Alliance Program textiles.

When specifying a striped or directional textile, a solid pattern is recommended for the back cushion due to alignment constraints.

Contrasting textiles or leather are available. Use an electronic specification tool for accurate pricing.

Models that meet TB133 requirements are available in select textiles or leather.

▶ Contact **By Design**.

How to Specify

- ① Model
 - Frame (primary):
 - ② Textile or leather grade or Alliance prefix + grade
 - ③ Textile or leather number
 - Back Cushion:
 - ④ Textile or leather grade or Alliance prefix + grade
 - ⑤ Textile or leather number
 - Seat Cushion:
 - ⑥ Textile or leather grade or Alliance prefix + grade
 - ⑦ Textile or leather number
 - ⑧ Leg option:
 - ▶ See page BO.4 for designators.

| Model | Description | Kimball International Seating Textile/Leather Price Grade | | | | | | | | | | Shipping | | GSA |
|---------------|--------------------------|---|-------|-------|------|------|------|------|------|-------|--------|------------|-------|-----|
| | | 1 | 2/COM | 3/COL | 4 | 5 | 6 | 7 | L7 | L8 | lbs. | Cubic Feet | SIN | |
| K743AT | Sewn-tufted back cushion | \$5497 | 5987 | 6249 | 6568 | 7029 | 7480 | 7932 | 9830 | 10903 | 196.00 | 52.30 | 33721 | |
| K743A | Standard back cushion | \$4632 | 5122 | 5384 | 5703 | 6164 | 6615 | 7067 | 8965 | 10038 | 196.00 | 52.30 | 33721 | |

| Model | Alliance Program Seating Textile Price Grade | | | | | | | | | | | | | | | | | |
|---------------|--|------|------|------|------|------|------|------|------|------|------|-------|-------|-------|-------|-------|-------|-------|
| | A | B | C | D | E | F | G | H | I | J | K | L | M | N | O | P | Q | R |
| K743AT | \$6203 | 6540 | 6804 | 7075 | 7368 | 7707 | 7895 | 8271 | 8579 | 8901 | 9408 | 10422 | 11071 | 11222 | 11345 | 11504 | 11655 | 12368 |
| K743A | \$5338 | 5675 | 5939 | 6210 | 6503 | 6842 | 7030 | 7406 | 7714 | 8036 | 8543 | 9557 | 10206 | 10357 | 10480 | 10639 | 10790 | 11503 |

| Description | Dimensions (Inches) | | | | | | |
|-----------------------|---------------------|-----|----|------|-----|----|-----|
| | Overall | | | Seat | | | Arm |
| | H | W | D | H | W | D | H |
| Sewn-tufted cushion | 32 | 73½ | 30 | 19 | 67½ | 19 | 26½ |
| Standard back cushion | 32 | 73½ | 30 | 19 | 67½ | 19 | 26½ |

| | |
|-------------------|-----------------|
| Statement of Line | ▶ See page BO.2 |
| Planning | BO.3 |
| Pricing | BO.5 |
| Surface Materials | BO.8 |

Applies to:

- Boyd seating

Kimball International Seating Textiles

Price Grades 1–7

Kimball International Seating Leather

Price Grades L7 and L8

Alliance Program Textiles

Price Grades A–R

▶ See Surface Materials at www.kimballinternational.com for a wide variety of graded-in textiles from Arc-Com, Carnegie, CF Stinson, Maharam, Mayer Fabrics, Momentum, and Ultrafabrics.

▶ For a complete overview of the surface materials program, see the *Surface Materials Reference Guide* at www.kimballinternational.com

BOYD® SEATING

COM/COL Yardage Requirements

Surface Materials

| | |
|-------------------|-----------------|
| Statement of Line | ▶ See page BO.2 |
| Planning | BO.3 |
| Pricing | BO.5 |
| Surface Materials | BO.8 |

| MODEL | ENTIRE UNIT | | | | | BACK | | | | | SEAT | | | | | FRAME | | | | |
|---------------|--------------------|-------------|--------------|---------------|------------|------------|-------------|--------------|---------------|------------|--------------------|-------------|--------------|---------------|------------|------------|-------------|--------------|---------------|------------|
| | COM (Yards) | | | | | COL | | | | | COM (Yards) | | | | | COL | | | | |
| | Non-Dir. | 1-4" Repeat | 5-11" Repeat | 12-18" Repeat | (Sq. Feet) | Non-Dir. | 1-4" Repeat | 5-11" Repeat | 12-18" Repeat | (Sq. Feet) | Non-Dir. | 1-4" Repeat | 5-11" Repeat | 12-18" Repeat | (Sq. Feet) | Non-Dir. | 1-4" Repeat | 5-11" Repeat | 12-18" Repeat | (Sq. Feet) |
| K741A | 4.1 | 5.8 | 7.5 | 7.4 | 82.0 | 0.9 | 1.0 | 1.7 | 2.2 | 18.0 | 1.1 | 1.2 | 1.5 | 1.8 | 22.0 | 3.7 | 4.3 | 5.0 | 5.0 | 74.0 |
| K741AT | 4.5 | 6.2 | 7.5 | 7.8 | 90.0 | 0.9 | 1.4 | 1.7 | 2.2 | 18.0 | 1.1 | 1.2 | 1.5 | 1.8 | 22.0 | 3.7 | 4.3 | 5.0 | 5.0 | 74.0 |
| K742A | 6.0 | 8.9 | 11.1 | 12.2 | 119.5 | 1.5 | 1.8 | 3.3 | 4.2 | 30.0 | 1.5 | 2.2 | 3.0 | 3.8 | 30.0 | 4.0 | 5.4 | 6.3 | 6.0 | 80.0 |
| K742AT | 6.1 | 9.4 | 11.1 | 12.2 | 121.5 | 1.5 | 2.4 | 3.3 | 4.2 | 30.0 | 1.5 | 2.2 | 3.0 | 3.8 | 30.0 | 4.0 | 5.4 | 6.3 | 6.0 | 80.0 |
| K743A | 7.8 | 11.4 | 15.2 | 17.2 | 155.5 | 2.3 | 2.8 | 4.8 | 6.2 | 46.0 | 2.3 | 3.2 | 4.6 | 5.8 | 46.0 | 4.8 | 6.6 | 7.5 | 7.0 | 96.0 |
| K743AT | 8.2 | 12.7 | 15.2 | 17.2 | 163.5 | 2.3 | 3.8 | 4.8 | 6.2 | 46.0 | 2.3 | 3.2 | 4.6 | 5.8 | 46.0 | 4.8 | 6.6 | 7.5 | 7.0 | 96.0 |

Kimball has analyzed each model to most accurately reflect the COM/COL yardage requirements shown on the pricing pages. The yardage requirement for each model is based on 54"W textile and cutting the textile up the roll.

For widths other than 54", increase the yardage requirement by the factors below:

| <i>Textile width</i> | <i>Increase yardage</i> |
|----------------------|-------------------------|
| 50"-53" | 15% |
| 48"-49" | 30% |
| 45"-47" | 45% |

If repeat is larger than 18", contact Customer Service to confirm the correct amount of yardage required.

When ordering 10 or more chairs in the same COM, yardage requirements may be reduced.

▶ Contact Customer Service.