

---

# CONNOLLY

Product Specifications	108
Textiles and Options	109
Contrasting Textiles Specifications	110
Product Pages	111
Typicals	119
COM Yardage Requirements	120

## CONNOLLY PRODUCT SPECIFICATIONS

### FRAME CONSTRUCTION

- Interior frame is constructed of oriented strand board with tenon joints that are glued and stapled for maximum joint stability

### SEAT CONSTRUCTION

- Seat cushions on lounge chairs and benches are attached to frame and feature an 8½" cushion constructed of an inner steel springcoil pack enveloped by high grade polyurethane foam

### BACK & ARM CONSTRUCTION

- Back and arms consist of 2" high grade polyurethane foam
- Back foam wedge cushions are attached to the frame

### UPHOLSTERY DETAIL

- Contrasting fabric options available on lounge and bench models
- Stitch details on arm and extreme back of the lounge models are available in matching or contrasting thread colors
- Upholstery present on all benches are in alignment with upholstered lounge platform
- Comfort wrinkles on the back and seat cushions are an inherent part of the design

### TABLES

- Laminate surfaces are 1¾" thick HPL (high pressure laminate) and feature standard 3mm PVC edge
- Solid surfaces are 1" thick and feature a flat rim profile
- Compatible with undermount power

### LEGS

- Corner units feature one unique ganging leg. See assembly instructions for special instructions
- 8" tall, 1½" diameter steel tube powder-coated with adjustable glide
- 8" tall, 2" diameter tapered wood leg is solid beech and comes in multiple finish options with adjustable glide
- Shipped knocked down and installed in the field
- Starter models come with 2 standard legs and 2 ganging legs, add-ons come with two ganging legs, and end models come with 2 standard legs only. Unique hardware kits are shipped for proper attachment

### GLIDES

- Features 1" adjustable nylon leveling glides
- Soft, non-skid 1" adjustable glides are available for an additional upcharge

### POWER AND USB GROMMET - UNDERMOUNT

- UL Listed
- Features 1 power outlet and 2 USB (A) ports
- Available in black
- Field installable, unit can be placed on the underside of any flat surface

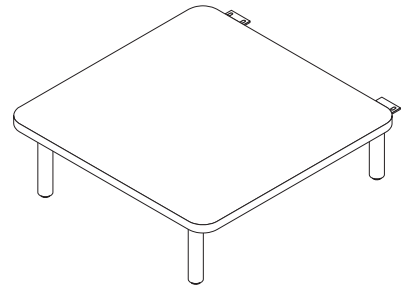
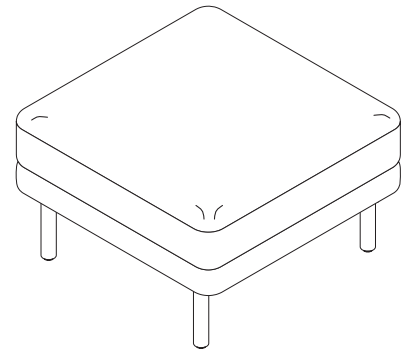
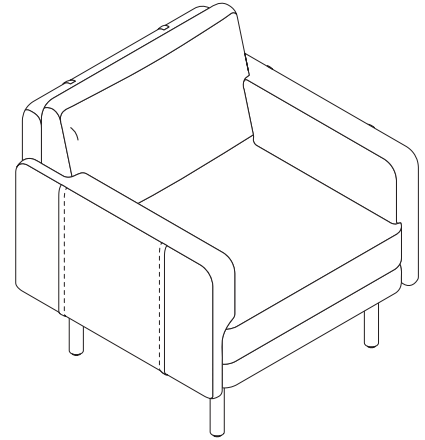

**TEXTILES**

Grade 1 Cali  
Entwine  
Input  
Melange  
Ridge  
Spark  
Vessel  
Zig Zag

Grade 2 Bliss  
Brilliant  
COM  
Dolce  
Dorset  
Intuition  
Phrase  
Pixie  
Sedona  
Stancil  
Strand

Grade 3 COL  
Silvertex

Grade 4 Connect Four  
Masquerade

Grade 5 Mode

Grade 6 Essence/Ultraleather

Grade 7 Brisa  
Brisa Distressed  
Reef Pro  
Silica  
Silica Etch  
Tottori

Grade L7 Davenport

Grade L8 Florence

**PAINT COLORS - METAL LEG**

**STANDARD PAINT**

437	Cement	463	Iron
462	Cinder	400	Linen
440	Cloud	454	Morrel
423	Concrete	443	Pavestone
457	Dapple	455	Quarry
405	Designer White	420	Sandstone
450	Fog	425	Shadow
109	Fossil	460	Storm
488	Frosty White	419	Wallaby
461	Graphite		

**METALLIC PAINT (+\$142 LIST)**

514	Carbon Metallic	503	Satin Nickel
547	Dark Bronze		Metallic
	Metallic	544	Silver Pearl
501	Platinum Metallic	504	Taupe Metallic

**GALLERY PAINT (+\$142 LIST)**

G2004	Blush	G2001	Moon Beam
G2006	Brick Red	G2010	Naval
G2003	Chive	G2013	Olive Branch
G2002	Dark Blue	G2011	Rustic Sun
G2008	Eucalyptus	G2005	Sangria
G2012	Ginkgo	G2009	Tidewater
G2007	Lavender Ash		

**WOOD LEG FINISH COLORS**

793	Acorn	KN	Kona
AD	Almond	MW	Midtown
MC	Amber	MH	Mocha
AC	Autumn	YO	Monterey
BZ	Brazilwood	NM	Natural
IM	Brighton	PC	Porcini
CO	Canyon	PT	Portico
CL	Caramel	PB	Portobello
CI	Chai	792	Sable
462	Cinder	SC	Sedona
CC	Cordoba	SK	Skyline
CW	Cordovan	TW	Tribeca
405	Designer White	TF	Truffle
DF	Driftwood	NW	Tuscan
HN	Honey	UW	Urban
TM	Huntington	WL	Willow
DW	Judicial		

**HPL LAMINATE TOP COLORS**

**WOODGRAIN LAMINATE**

793	Acorn	MW	Midtown
AD	Almond	MH	Mocha
MC	Amber	YO	Monterey
AC2	Autumn 2	NM	Natural
BZ	Brazilwood	PC	Porcini
IM	Brighton	PT	Portico
CO	Canyon	PB	Portobello
CL	Caramel	792	Sable
CI	Chai	SC	Sedona
CC	Cordoba	SK	Skyline
CW	Cordovan	TW	Tribeca
DF	Driftwood	TF	Truffle
HN2	Honey 2	NW	Tuscan
TM	Huntington	UW	Urban
DW	Judicial	WL	Willow
KN	Kona		

**SOLID LAMINATE**

462	Cinder	405	Fog
492	Cinder Linear	488	Frosty White
440	Cloud	461	Graphite
457	Dapple	478	Platinum Grey
405	Designer White	425	Shadow
491	Designer White	460	Storm
	Linear	419	Wallaby

**GALLERY LAMINATE**

Grade 1 – 5% upcharge  
G1001 Citadel  
G1011 Pepperdust

Grade 2 – 6% upcharge  
G1002 Planked Raw Oak  
G1003 Evening Notte  
G1004 Kirsche  
G1005 Midnight Run  
G1006 Sepia Walnut  
G1007 Serotina  
G1008 Timeless  
G1009 White Nebbia  
G1012 Phantom Ecru

**SOLID SURFACE TOP OPTIONS**

7101 Bisque (Grade A)  
7201 Glacier White (Grade A)  
7203 Designer White (Grade B)  
7204 Silt (Grade B)  
7301 Concrete (Grade C)  
7302 Deep Night Sky (Grade C)

**GLIDES**

STD Standard  
C66 Soft (add \$42 list)

**THREAD COLORS**

AA Matching  
AC Beige  
AN Black  
AE Dark Brown  
AK Dark Green  
AM Graphite  
AH Marine  
AJ Navy  
AF Red  
AD Saddle  
AL Silver  
AB White  
AG Wine

• For a complete overview of the surface materials program, see the Surface Materials Reference Guide at [www.kimballinternational.com](http://www.kimballinternational.com)  
• For special wood finishes, customer-specified paint, customer-specified laminate processes and upcharges, see the Surface Materials Reference Guide at [www.kimballinternational.com](http://www.kimballinternational.com)

## TO ORDER CONTRASTING TEXTILE, SPECIFY

### CONNOLLY

#### Freestanding Lounge Single Seat Armless page 111

#### Modular Lounge One Seat Armless page 114

#### Modular Lounge Corner page 114

1. Model Number plus "X"
2. Back Textile Grade Number/Cover Number
3. Extreme Back Textile Grade Number/Cover Number
4. Back Accent Textile Grade Number/Cover Number
5. Seat Textile Grade Number/Cover Number
6. Upholstery Grade Number/Cover Number
7. Thread Color
8. Finish
9. Glide

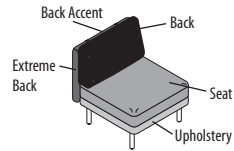

Freestanding Seat Armless  
Contrasting Upholstery

#### Freestanding Lounge Single Seat with Arms page 111

#### Freestanding Lounge Two Seat with Arms page 112

#### Freestanding Lounge Three Seat with Arms page 112

#### Modular Lounge One Seat with Arm page 114

1. Model Number plus "X"
2. Back Textile Grade Number/Cover Number
3. Extreme Back Textile Grade Number/Cover Number
4. Back Accent Textile Grade Number/Cover Number
5. Seat Textile Grade Number/Cover Number
6. Upholstery Grade Number/Cover Number
7. Arm Textile Grade Number/Cover Number
8. Accent Textile Grade Number/Cover Number
9. Thread Color
10. Finish
11. Glide

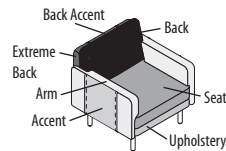

Freestanding Seat  
Contrasting Upholstery

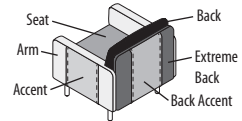

Contrasting Upholstery Back View

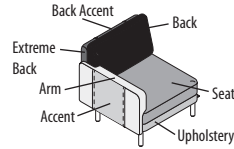

Modular Seat Contrasting Upholstery

#### Freestanding One Seat Bench page 113

#### Freestanding Two Seat Bench page 113

#### Freestanding Three Seat Bench page 113

#### Modular Bench page 115

#### Modular Corner Bench page 115

1. Model Number plus "X"
2. Seat Textile Grade Number/Cover Number
3. Upholstery Grade Number/Cover Number
4. Finish
5. Glide

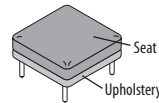

Freestanding Bench  
Contrasting Upholstery

**TO ORDER, SPECIFY:**

1. Model Number
2. Textile Grade Number / Cover Number
3. Thread Color
4. Paint or Finish
5. Glide

• See page 109 for Connolly options  
See pages 120-121 for COM textile yardage

**FREESTANDING LOUNGE  
SINGLE SEAT ARMLESS**

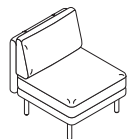

Metal Legs

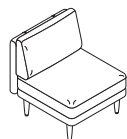

Wood Legs

**MODEL  
NO.**

**GRADE / LIST PRICE**

		1	2/COM	3/COL	4	5	6	7	L7	L8
N72LF1MM	Single Seat, Armless, Metal Legs	\$ 2050	2205	2278	2390	2514	2729	3013	4355	4785
N72LF1MW	Single Seat, Armless, Wood Legs	2400	2555	2628	2740	2864	3079	3363	4705	5135

**DIMENSIONS**

Width	28	Seat Width	28	Back Width	28	Weight	40
Depth	30½	Seat Depth	22			Cubic Ft.	17.5
Height	32½	Seat Height	17				

- Contrasting textile option – specify X (i.e., N72LF1MWX); see page 110. For list pricing, use your electronic specification tool or contact customer service
- Legs shipped unattached for installment in the field

**FREESTANDING LOUNGE  
SINGLE SEAT WITH ARMS**

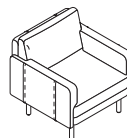

Metal Legs

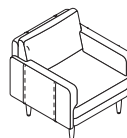

Wood Legs

		1	2/COM	3/COL	4	5	6	7	L7	L8
N72LF1AM	Single Seat, Arms, Metal Legs	\$ 2600	2794	2886	3027	3183	3453	3810	5494	6034
N72LF1AW	Single Seat, Arms, Wood Legs	2950	3144	3236	3377	3533	3803	4160	5844	6384

**DIMENSIONS**

Width	32½	Seat Width	24	Arm Height	25	Back Width	28	Weight	104
Depth	30½	Seat Depth	22	Arm Width	4			Cubic Ft.	17.5
Height	32½	Seat Height	17						

- Contrasting textile option – specify X (i.e., N72LF1AWX); see page 110. For list pricing, use your electronic specification tool or contact customer service
- Legs shipped unattached for installment in the field

**TO ORDER, SPECIFY:**

1. Model Number
2. Textile Grade Number / Cover Number
3. Thread Color
4. Paint or Finish
5. Glide

• See page 109 for Connolly options  
 See pages 120-121 for COM textile yardage

**FREESTANDING LOUNGE  
TWO SEAT**

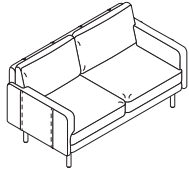

Metal Legs

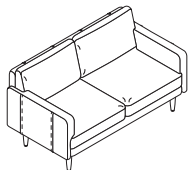

Wood Legs

**MODEL  
NO.**

**GRADE / LIST PRICE**

		1	2/COM	3/COL	4	5	6	7	L7	L8
N72LF2AM	Two Seat, Metal Legs	\$ 3900	4206	4351	4572	4818	5243	5804	8456	9306
N72LF2AW	Two Seat, Wood Legs	4250	4556	4701	4922	5168	5593	6154	8806	9656

**DIMENSIONS**

Width	60	Seat Width	52	Arm Height	25	Back Width	52	Weight	156
Depth	30½	Seat Depth	22	Arm Width	4			Cubic Ft.	31.0
Height	32½	Seat Height	17						

- Contrasting textile option – specify X (i.e., N72LF2AWX); see page 110. For list pricing, use your electronic specification tool or contact customer service
- Legs shipped unattached for installment in the field

**FREESTANDING LOUNGE  
THREE SEAT**

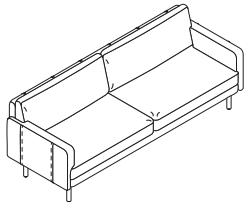

Metal Legs

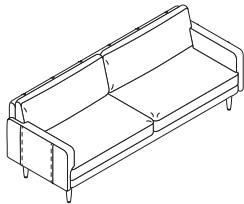

Wood Legs

		1	2/COM	3/COL	4	5	6	7	L7	L8
N72LF3AM	Three Seat, Metal Legs	\$ 5300	5660	5830	6090	6380	6880	7540	10660	11660
N72LF3AW	Three Seat, Wood Legs	5725	6085	6255	6515	6805	7305	7965	11085	12085

**DIMENSIONS**

Width	87½	Seat Width	79½	Arm Height	25	Back Width	79½	Weight	198
Depth	30½	Seat Depth	22	Arm Width	4			Cubic Ft.	45.0
Height	32½	Seat Height	17						

- Contrasting textile option – specify X (i.e., N72LF3AMX); see page 110. For list pricing, use your electronic specification tool or contact customer service
- Legs shipped unattached for installment in the field

**TO ORDER, SPECIFY:**

1. Model Number
2. Textile Grade Number / Cover Number
3. Paint or Finish
4. Glide

• See page 109 for Connolly options  
See pages 120-121 for COM textile yardage

**FREESTANDING BENCH  
ONE SEAT**

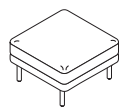

Metal Legs

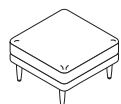

Wood Legs

**MODEL  
NO.**

**GRADE / LIST PRICE**

		1	2/COM	3/COL	4	5	6	7	L7	L8
N72BF1M	One Seat, Metal Legs	\$ 1582	1681	1728	1799	1879	2017	2198	3056	3331
N72BF1W	One Seat, Wood Legs	1932	2031	2078	2149	2229	2367	2548	3406	3681

**DIMENSIONS**

Width	28							Weight	40
Depth	28							Cubic Ft.	9.0
Height	17								

- Contrasting textile option – specify X (i.e., N72BF1WX); see page 110. For list pricing, use your electronic specification tool or contact customer service
- Legs shipped unattached for installment in the field

**FREESTANDING BENCH  
TWO SEAT**

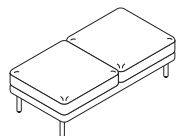

Metal Legs

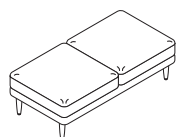

Wood Legs

		1	2/COM	3/COL	4	5	6	7	L7	L8
N72BF2M	Two Seat, Metal Legs	\$ 1978	2162	2248	2381	2529	2784	3120	4712	5222
N72BF2W	Two Seat, Wood Legs	2328	2512	2598	2731	2879	3134	3470	5062	5572

**DIMENSIONS**

Width	65							Weight	78
Depth	28							Cubic Ft.	18.5
Height	17								

- Contrasting textile option – specify X (i.e., N72BF2WX); see page 110. For list pricing, use your electronic specification tool or contact customer service
- Legs shipped unattached for installment in the field

**FREESTANDING BENCH  
THREE SEAT**

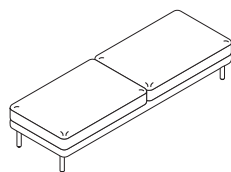

Metal Legs

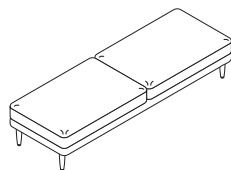

Wood Legs

		1	2/COM	3/COL	4	5	6	7	L7	L8
N72BF3M	Two Seat, Metal Legs	\$ 2630	2803	2884	3009	3148	3388	3705	5203	5683
N72BF3W	Two Seat, Wood Legs	3055	3228	3309	3434	3573	3813	4130	5628	6108

**DIMENSIONS**

Width	83½							Weight	112
Depth	28							Cubic Ft.	27.0
Height	17								

- Contrasting textile option – specify X (i.e., N72BF3WX); see page 110. For list pricing, use your electronic specification tool or contact customer service
- Legs shipped unattached for installment in the field

**TO ORDER, SPECIFY:**

1. Model Number
2. Textile Grade Number / Cover Number
3. Thread Color
4. Paint or Finish
5. Glide

• See page 109 for Connolly options  
See pages 120-121 for COM textile yardage

**MODULAR LOUNGE  
ONE SEAT ARMLESS**

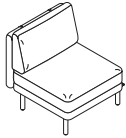

Starter, Metal Legs

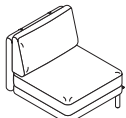

Add-On, Metal Legs



End, Metal Legs

**MODEL  
NO.**

**GRADE / LIST PRICE**

		1	2/COM	3/COL	4	5	6	7	L7	L8
N72LS1MM	Armless, Starter, Metal Legs	\$ 2147	2302	2375	2487	2611	2826	3110	4452	4882
N72LA1MM	Armless, Add-On, Metal Legs	2034	2189	2262	2374	2498	2713	2997	4339	4769
N72LE1MM	Armless, End, Metal Legs	2034	2189	2262	2374	2498	2713	2997	4339	4769
N72LS1MW	Armless, Starter, Wood Legs	2497	2652	2725	2837	2961	3176	3460	4802	5232
N72LA1MW	Armless, Add-On, Wood Legs	2187	2342	2415	2527	2651	2866	3150	4492	4922
N72LE1MW	Armless, End, Wood Legs	2187	2342	2415	2527	2651	2866	3150	4492	4922

**DIMENSIONS**

Width	28	Seat Width	28	Back Width	28	Weight	62
Depth	30½	Seat Depth	22			Cubic Ft.	17.5
Height	32½	Seat Height	17				

- Contrasting textile option – specify X (i.e., N72LS1MWX); see page 110. For list pricing, use your electronic specification tool or contact customer service
- When using ganging models, a “Starter” model must be used at the start of a run and an “End” model to end the run. “Add-on” models are used between the starter and end to add additional seats
- Ganging hardware is integrated within the leg design, shipped unattached

**MODULAR LOUNGE  
ONE SEAT WITH ARM**



Right Arm, Starter, Metal Legs

		1	2/COM	3/COL	4	5	6	7	L7	L8
N72LS1RM	Right Arm, Starter, Metal Legs	\$ 2373	2546	2627	2752	2891	3131	3448	4946	5426
N72LE1LM	Left Arm, End, Metal Legs	2252	2425	2506	2631	2770	3010	3327	4825	5305
N72LS1RW	Right Arm, Starter, Wood Legs	2723	2896	2977	3102	3241	3481	3798	5296	5776
N72LE1LW	Left Arm, End, Wood Legs	2405	2578	2659	2784	2923	3163	3480	4978	5458

**DIMENSIONS**

Width	32½	Seat Width	24	Arm Height	25	Back Width	28	Weight	84
Depth	30½	Seat Depth	22	Arm Width	4			Cubic Ft.	31.0
Height	32½	Seat Height	17						

- Contrasting textile option – specify X (i.e., N72LS1RWX); see page 110. For list pricing, use your electronic specification tool or contact customer service
- When using ganging models, a “Starter” model must be used at the start of a run and an “End” model to end the run. “Add-on” models are used between the starter and end to add additional seats
- Ganging hardware is integrated within the leg design, shipped unattached

**MODULAR LOUNGE  
CORNER**

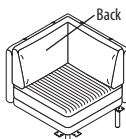

Metal Legs

		1	2/COM	3/COL	4	5	6	7	L7	L8
N72LACNMM	90° Corner, Add-On, Metal Legs	\$ 2500	2673	2754	2879	3018	3258	3575	5073	5553
N72LACNMW	90° Corner, Add-On, Wood Legs	2850	3023	3104	3229	3368	3608	3925	5423	5903

**DIMENSIONS**

Width	30½	Seat Width	22	Weight	82
Depth	30½	Seat Depth	22	Cubic Ft.	31.0
Height	32½	Seat Height	17		

- Contrasting textile option – specify X (i.e., N72LACNMWX); see page 110. For list pricing, use your electronic specification tool or contact customer service
- When using ganging models, a “Starter” model must be used at the start of a run and an “End” model to end the run. “Add-on” models are used between the starter and end to add additional seats
- Ganging hardware is integrated within the leg design, shipped unattached
- Corner units feature one unique ganging leg. See assembly instructions for special instructions



**TO ORDER, SPECIFY:**

1. Model Number
2. Textile Grade Number / Cover Number
3. Paint or Finish
4. Glide

• See page 109 for Connolly options  
See pages 120-121 for COM textile yardage

**MODULAR BENCH**

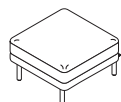

Starter, Metal Legs

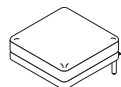

Add-On, Metal Legs

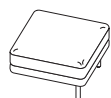

End, Metal Legs

**MODEL NO.**

**GRADE / LIST PRICE**

			1	2/COM	3/COL	4	5	6	7	L7	L8
N72BS1M	One Seat, Starter, Metal Legs	\$	1469	1568	1615	1686	1766	1904	2085	2943	3218
N72BA1M	One Seat, Add-On, Metal Legs		1356	1455	1502	1573	1653	1791	1972	2830	3105
N72BE1M	One Seat, End, Metal Legs		1356	1455	1502	1573	1653	1791	1972	2830	3105
N72BS1W	One Seat, Starter, Wood Legs		1819	1918	1965	2036	2116	2254	2435	3293	3568
N72BA1W	One Seat, Add-On, Wood Legs		1509	1608	1655	1726	1806	1944	2125	2983	3258
N72BE1W	One Seat, End Wood, Legs		1509	1608	1655	1726	1806	1944	2125	2983	3258

**DIMENSIONS**

Width	28									Weight	40
Depth	28									Cubic Ft.	9.0
Height	17										

- Contrasting textile option – specify X (i.e., N72BS1WX); see page 110. For list pricing, use your electronic specification tool or contact customer service
- Ganging hardware is integrated within the leg design, shipped unattached

**MODULAR CORNER BENCH**

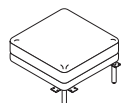

Metal Legs

			1	2/COM	3/COL	4	5	6	7	L7	L8
N72BACNM	90° Corner, Add-On, Metal Legs	\$	1356	1455	1502	1573	1653	1791	1972	2830	3105
N72BACNW	90° Corner, Add-On, Wood Legs		1706	1805	1852	1923	2003	2141	2322	3180	3455

**DIMENSIONS**

Width	28									Weight	40
Depth	28									Cubic Ft.	9.0
Height	17										

- Contrasting textile option – specify X (i.e., N72BACNWX); see page 110. For list pricing, use your electronic specification tool or contact customer service
- Ganging hardware is integrated within the leg design, shipped unattached
- Corner units feature one unique ganging leg. See assembly instructions for special instructions

**TO ORDER, SPECIFY:**

• See page 109 for Connolly options

1. Model Number
2. Laminate/Solid Surface Color
3. Paint or Finish
4. Glide

**MODULAR SQUARE TABLE**

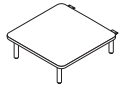

Starter, HPL, Metal Legs



Add-On, HPL, Metal Legs



End, HPL, Metal Legs

**MODEL NO.**

**LIST PRICE**

N72TS28SQLM	Starter, HPL, Metal Legs	\$ 1243
N72TS28SQSM	Starter, Solid Surface, Metal Legs	2600
N72TA28SQLM	Add-On, HPL, Metal Legs	1140
N72TA28SQSM	Add-On, Solid Surface, Metal Legs	2550
N72TE28SQLM	End, HPL, Metal Legs	1140
N72TE28SQSM	End, Solid Surface, Metal Legs	2550
N72TS28SQLW	Starter, HPL, Wood Legs	1593
N72TS28SQSW	Starter, Solid Surface, Wood Legs	2950
N72TA28SQLW	Add-On, HPL, Wood Legs	1293
N72TA28SQSW	Add-On, Solid Surface, Wood Legs	2703
N72TE28SQLW	End, HPL, Wood Legs	1293
N72TE28SQSW	End, Solid Surface, Wood Legs	2703

**DIMENSIONS**

Width	27¾	Laminate Weight	29
Depth	27¾	Solid Surface Weight	38
Height	9	Cubic Ft.	4.88

- Legs shipped unattached for installment in the field
- Ganging hardware is integrated within the leg design, shipped unattached (if applicable)

**MODULAR RECTANGULAR TABLE**

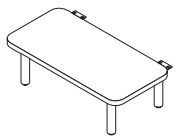

Starter, HPL, Metal Legs



Add-On, HPL, Metal Legs

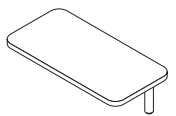

End, HPL, Metal Legs

N72TS14RTLW	Starter, HPL, Metal Legs	\$ 950
N72TS14RTSM	Starter, Solid Surface, Metal Legs	1975
N72TA14RTLW	Add-On, HPL, Metal Legs	850
N72TA14RTSM	Add-On, Solid Surface, Metal Legs	1875
N72TE14RTLW	End, HPL, Metal Legs	850
N72TE14RTSM	End, Solid Surface, Metal Legs	1875
N72TS14RTLW	Starter, HPL, Wood Legs	1300
N72TS14RTSW	Starter, Solid Surface, Wood Legs	2325
N72TA14RTLW	Add-On, HPL, Wood Legs	1003
N72TA14RTSW	Add-On, Solid Surface, Wood Legs	2028
N72TE14RTLW	End, HPL, Wood Legs	1003
N72TE14RTSW	End, Solid Surface, Wood Legs	2028

**DIMENSIONS**

Width	27¾	Laminate Weight	16.5
Depth	13¾	Solid Surface Weight	21
Height	9	Cubic Ft.	2.48

- Legs shipped unattached for installment in the field
- Ganging hardware is integrated within the leg design, shipped unattached (if applicable)

**TO ORDER, SPECIFY:**

• See page 109 for Connolly options

1. Model Number
2. Laminate/Solid Surface Color
3. Paint or Finish
4. Glide

**MODULAR 90° CORNER TABLE**



HPL, Metal Legs

MODEL NO.		LIST PRICE
N72TA28CNLM	Add-On, HPL, Metal Legs	\$ 1240
N72TA28CNSM	Add-On, Solid Surface, Metal Legs	2650
N72TA28CNLW	Add-On, HPL, Wood Legs	1393
N72TA28CNSW	Add-On, Solid Surface, Wood Legs	2803

**DIMENSIONS**

Width	27¾	Laminate Weight	29
Depth	27¾	Solid Surface Weight	38
Height	9	Cubic Ft.	4.88

- Legs shipped unattached for installment in the field
- Ganging hardware is integrated within the leg design, shipped unattached (if applicable)
- Corner units feature one unique ganging leg. See assembly instructions for special instructions

**MODULAR 120° CORNER TABLE**



HPL, Metal Legs

N72TA53CNLM	Add-On, HPL, Metal Legs	\$ 1600
N72TA53CNSM	Add-On, Solid Surface, Metal Legs	5200
N72TA53CNLW	Add-On, HPL, Wood Legs	1950
N72TA53CNSW	Add-On, Solid Surface, Wood Legs	5550

**DIMENSIONS**

Width	52¾	Laminate Weight	39
Depth	27¾	Solid Surface Weight	93
Height	9	Cubic Ft.	4.91

- Legs shipped unattached for installment in the field
- Ganging hardware is integrated within the leg design, shipped unattached (if applicable)
- Corner units feature one unique ganging leg. See assembly instructions for special instructions

**TO ORDER, SPECIFY:**

• See page 109 for Connolly options

1. Model Number

**UNDERMOUNT  
USB POWER UNIT**

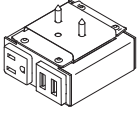

MODEL NO.		LIST PRICE	CARTONED WEIGHT	CUBIC FEET
NAC03ELUPDC	Black only	\$ 392	2 lbs.	0.3

**DIMENSIONS**

Width	3
Depth	3
Height	1½

- Can be mounted to the underside of any flat surface
- Features 1 power outlet and 2 USB (A) ports
- 72" 15 amp cord

**UNDERMOUNT  
MINI-TAP OUTLET**

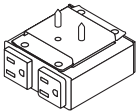

NAC03ELUPPC	Black only	\$ 163	1.2 lbs.	2.3
-------------	------------	--------	----------	-----

**DIMENSIONS**

Width	3
Depth	3
Height	1½

- For use on Desk Nook when power and light are both specified
- Available to power TV on 66" Privacy Panel with Media and Table

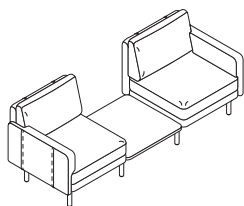

MODEL NO.	QUANTITY	DESCRIPTION	GRADE 1 LIST PRICE
N72LS1RM	(1)	Right Arm, 1 Seat Lounge Starter, Metal Legs	\$ 2373
N72TA28SQLM	(1)	Square Table Add-On, HPL, Metal Legs	1140
N72LE1LM	(1)	Left Arm, 1 Seat Lounge End, Metal Legs	2252
Total			\$ 5765

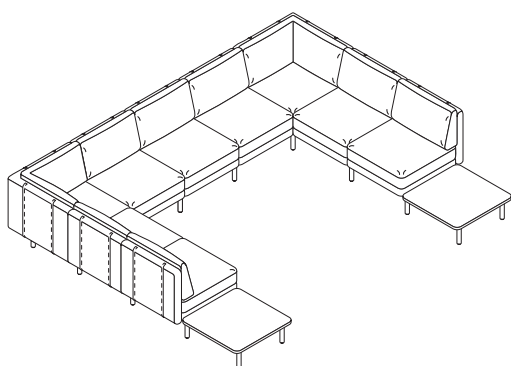

MODEL NO.	QUANTITY	DESCRIPTION	GRADE 1 LIST PRICE
N72TS28SQLM	(1)	Square Table Starter, HPL, Metal Legs	\$ 1243
N72LA1MM	(7)	Armless, 1 Seat Lounge Add-On, Metal Legs	2034 ea
N72LACNMM	(2)	90° Corner, Lounge, Metal Legs	2500 ea
N72TE28SQLM	(1)	Square Table End, HPL, Metal Legs	1140
Total			\$ 21,621

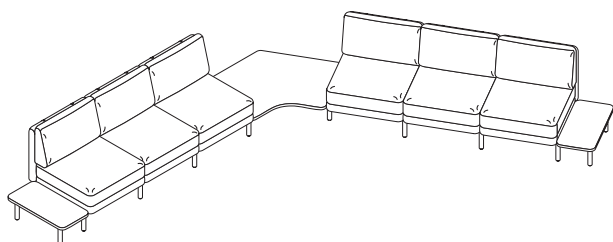

MODEL NO.	QUANTITY	DESCRIPTION	GRADE 1 LIST PRICE
N72TS14RTL	(1)	Rectangular Table Starter, HPL, Metal Legs	\$ 950
N72LA1MM	(6)	Armless, 1 Seat Lounge Add-On, Metal Legs	2034 ea
N72TA53CNLM	(1)	120° Table Add-on, HPL, Metal Legs	1600
N72TE14RTL	(1)	Rectangular Table End, HPL, Metal Legs	850
Total			\$ 15,604

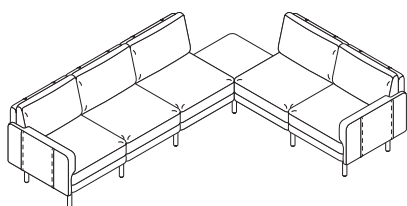

MODEL NO.	QUANTITY	DESCRIPTION	GRADE 1 LIST PRICE
N72LS1RM	(1)	Right Arm, 1 Seat Lounge Starter, Metal Legs	\$ 2373
N72LA1MM	(3)	Armless, 1 Seat Lounge Add-On, Metal Legs	2034 ea
N72TA28CNLM	(1)	90° Corner Table Add-On, HPL, Metal Legs	1240
N72LE1LM	(1)	Left Arm, 1 Seat Lounge End, Metal Legs	2252
Total			\$ 11,967

# COM YARDAGE REQUIREMENTS

## COM YARDAGE REQUIREMENTS (54" WIDTH – CUT UP THE ROLL)

MODEL	RAILROADED Contact customer service 800-482-1717 for ydg requirements	NON DIRECTIONAL OR SOLID	1"-4" REPEAT	5"-11" REPEAT	12"-18" REPEAT	COL SQUARE FEET
			4" VERTICAL X 4" HORIZONTAL	11" VERTICAL X 11" HORIZONTAL	18" VERTICAL X 18" HORIZONTAL	
If repeat is larger than 18", contact Customer Service to confirm the correct amount of yardage required						
N72BF1M, N72BF1W, N72BA1M, N72BA1W, N72BE1M, N72BE1W, N72BS1M, N72BS1W, N72BACNW, N72BACNM		2.80	3.30	4.40	6.10	54.79
N72BF1MX, N72BF1WX, N72BA1MX, N72BA1WX, N72BE1MX, N72BE1WX, N72BS1MX, N72BS1WX, N72BACNWX, N72BACNMX	Seat Upholstery	2.10 0.80	2.40 1.10	3.10 1.60	4.10 2.60	40.95 15.5
N72BF2M, N72BF2W		5.10	6.20	7.70	10.60	101.83
N72BF2MX, N72BF2WX	Seat Upholstery	4.00 1.20	4.60 2.10	5.90 2.30	7.60 3.60	79.7 23.8
N72BF3M, N72BF3W		4.80	5.90	7.10	10.60	101.28
N72BF3MX, N72BF3WX	Seat Upholstery	4.00 1.40	4.60 2.10	5.60 2.30	7.60 3.60	80.25 27.67
N72LF1AW, N72LF1AM		5.40	6.70	9.50	10.60	107.37
N72LF1AWX, N72LF1AMX	Accent Arm Back Back Accent Extreme Seat Upholstery	0.60 1.60 0.90 0.90 0.90 2.10 0.80	0.80 2.30 1.20 1.00 1.30 2.40 1.10	1.20 3.20 1.50 1.30 1.60 3.10 1.60	2.30 3.80 1.80 1.40 2.40 4.10 2.60	12.73 31.55 18.82 17.16 17.16 40.95 15.5
N72LACNMM, N72LACNMW		4.80	6.10	8.60	11.10	94.64
N72LACNMMX, N72LACNMWX	Back Back Accent Extreme Seat Upholstery	1.60 0.90 1.10 2.10 0.80	2.20 1.00 1.80 2.40 1.10	2.70 1.30 2.50 3.10 1.60	3.10 2.40 3.40 4.10 2.60	32.1 17.16 22.14 40.95 15.5
N72LF1MW, N72LA1MM, N72LA1MW, N72LE1MM, N72LE1MW, N72LS1MM, N72LS1MW		4.30	4.80	6.80	7.60	85.23
N72LF1MWX, N72LA1MMX, N72LA1MWX, N72LE1MMX, N72LE1MWX, N72LS1MMX, N72LS1MWX	Back Back Accent Extreme Seat Upholstery	0.90 0.90 0.90 2.10 0.80	1.20 1.00 1.30 2.40 1.10	1.50 1.30 1.60 3.10 1.60	1.80 1.40 2.40 4.10 2.60	18.82 17.16 17.16 40.95 15.5
N72LF2AM, N72LF2AW		8.50	10.50	14.30	18.10	169.35
N72LF2AMX, N72LF2AWX	Accent Arm Back Back Accent Extreme Seat Upholstery	0.60 1.60 2.20 0.90 1.10 4.00 1.20	0.80 2.30 2.50 1.00 1.50 4.60 2.10	1.10 3.10 3.10 1.30 2.50 5.90 2.30	2.10 3.60 3.60 1.40 3.40 7.60 3.60	12.73 31.55 43.17 17.16 22.14 79.7 23.8
N72LF3AM, N72LF3AW		10.00	13.20	16.60	19.10	199.24
N72LF3AMX, N72LF3AWX	Accent Arm Back Back Accent Extreme Seat Upholstery	0.60 1.60 2.20 0.90 1.70 4.00 1.40	0.80 2.30 3.00 1.90 2.40 4.60 2.10	1.20 3.20 3.30 2.20 2.80 5.60 2.30	2.30 3.80 4.20 2.40 3.90 7.60 3.60	12.73 31.55 43.17 17.16 33.76 80.25 27.67
N72LS1RM, N72LS1LM, N72LE1LW, N72LS1RW		4.80	5.60	7.70	9.10	95.19

## COM YARDAGE REQUIREMENTS

### COM YARDAGE REQUIREMENTS (54" WIDTH – CUT UP THE ROLL)

MODEL	RAILROADED Contact customer service 800-482-1717 for ydg requirements	NON DIRECTIONAL OR SOLID	1"-4" REPEAT	5"-11" REPEAT	12"-18" REPEAT	COL SQUARE FEET
			4" VERTICAL X 4" HORIZONTAL	11" VERTICAL X 11" HORIZONTAL	18" VERTICAL X 18" HORIZONTAL	
If repeat is larger than 18", contact Customer Service to confirm the correct amount of yardage required						
N72LS1RMX, N72LS1LMX, N72LE1LWX, N72LS1RWX	Accent	0.60	0.80	1.20	1.30	12.73
	Arm	1.50	1.70	2.00	2.30	29.89
	Back	0.90	1.20	1.50	1.80	18.82
	Back Accent	0.90	1.00	1.30	1.40	17.16
	Extreme	0.90	1.30	1.60	2.40	17.16
	Seat	2.10	2.40	3.10	4.10	40.95
	Upholstery	0.80	1.10	1.60	2.60	15.5

